

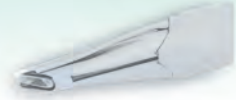

Pantolon Apereleri
Trousers Attachments
01-37



Eşofman ve Tişört Apereleri
Training Wear Attachments
38-77



İç Çamaşırı ve Mayo Apereleri
Underwear Attachments
78-88



Gömlek Apereleri
Shirt Attachments
89-102



Special Apereler
Related Special Attachments
103-120



**Türkiye'de Dikiş
Makineleri Aperelerinin ilk imalatçısı olan,
SÜRÜCÜ MAKİNA BAKIM SANAYİ, 1974 yılında Selami Sürücü tarafından**

kuruldu. İlk önceleri Çağaloğlu'nda küçük bir atölyede imalata başlayan firma, bugün 20 personeli, Unkapanı'ndaki merkez ofisi ve Ümraniye'deki fabrika ve showroom'unda 1400 m²'yi aşkın alanda tekstil ve konfeksiyon sanayine hizmet vermektedir. Bir aile şirketi olan SÜRÜCÜ APERE; pantolon, eşofman, tişört, gömlek, yatak örtüleri ve yorganlar, havlu-bornoz, cüzdan, çanta, kemer vb. tekstil ürünlerinin imalatı için dikiş makinaları üretmektedir. Bunların aynı zamanda bağlantı parçalarını da temin etmektedir.

Aperelerimizin ana kısımları BA 304 türü paslanmaz sacdan imal edilmekte olup, kesim işlemi laser ile yapılmaktadır. Böylece çapak ve pürüzlerden uzak kenarlar elde edilmektedir. Bağlantı kısımları HRP türü metalden olup kalaylama ile bir araya getirilmektedir. Eğer ekstra bir mukavemet gerekli ise kalay yerine gümüş kullanılmaktadır.

Şirket politikamız, müşterilerimize dünya çapında yüksek kaliteli ürünler, yenilikler sunmaktır. Sürücü apereleri en yüksek verimliliği sağlayacak standartlarda ve kalitede üretilmektedir. Müşteri ihtiyaçları tarafımızdan analiz edildikten sonra maksimum verim için aperelerimiz fabrikamızda bulunan gerçek dikiş makinalarında test edilebilmektedir. Böylece pratikte meydana gelebilecek aksaklıklar minimuma indirilmiş olmaktadır.

Bizlerin başayarı ulaşmak için izlediği stratejilerinde müşterilerimiz önemli bir rol oynamaktadır ve de öyle olmaya devam edeceklerdir. Sürücü % 100 müşteri memnuniyeti ilkesini benimsemiştir. Buna ulaşmak için; ileri teknoloji ürünü makinalar, alanlarında uzman personel ve süregelen ar-ge çalışmalarını esas tutmuştur. Müşterilerin ihtiyaçlarına özel siparişleri, yeni giyim modellerinin apereleri uzman kadromuz tarafından kısa sürede, başarıyla üretilebilmektedir. Firmamızın sektörde haklı bir yer edinmesinin arkasındaki en önemli noktalardan biranesi, müşterileri taleplerini dikkatle ele alması ve kısa zamanda bu ihtiyaçlara yüksek kaliteli ürünler ile cevap vermesidir. Müşterilerimiz ile düzenli ve sağlıklı bir iletişimi en üst düzeyde tutmak tüm firma düzeyinde hedef tutulmaktadır. İşbirliğine izin veren bir ortam içerisinde takım çalışması ile her zaman en iyiye ulaşmanın gayretinde olan Sürücü, tecrübeli ve alanlarında usta ekibi ile sektörde üst seviyede bir çizgi izlemektedir. Sürücü, motivasyonu yüksek ve işlerine odaklanmış çalışanları bir arada yüksek verim ile, kaliteli ürünler vereceğinin bilincindedir.

Sürücü Apere tekstil endüstrisinin ihtiyaçlarını derinlemesine analiz ederek, bu talepleri kusursuz denebilecek düzeyde ürünler ile karşılamış ve uzun vadeli bir başarı elde etmiştir.

Bugüne kadar tekstil sektöründe birçok önde gelen firmanın ihtiyacını karşılayan Sürücü, aynı zamanda İtalya, Fransa, Polonya, Norveç, İsveç, Litvanya, Letonya, Romanya, Hindistan, Mısır gibi ülkelere ihracatı vardır ve yurtdışı pazarındaki yeri de kaydedeğer bir biçimde büyümektedir.

KOSGEB üyesi olan, ISO 9001:2000 Kalite Belgelii şirketimiz; yılların tecrübe ve birikimiyle her geçen gün yükselen bir trend izleyerek, alanında lider konumda olmanın haklı gururunu yaşıyor. Güvenilir bir firma ile çalışmak istiyorsanız, doğru yerdesiniz.

COMPANY DESCRIPTION

SURUCU MACHINE & MAINTENANCE INDUSTRIES - the first producer of Sewing Attachments & Folders in Turkey - was founded in 1974 by Selami Surucu. The company began manufacturing in a small workshop in Çağaloğlu (Istanbul) and today, continues to serve textile industry worldwide with 20 personnel, a Head Office in Unkapanı and a Manufacturing Factory & Showroom over 1400 sqm indoor area in Ümraniye.

Surucu is a well established family firm, mainly, producing sewing machine attachments and folders for manufacture of trousers, training wears, underwears, shirts, bed quilt attachments, towel bathrobes and cases attachments. We also supply connectors for these.

Main parts of our products are made of BA 304 type stainless sheets and we use laser cutting machine which results in clean and burr free edges. Connection parts are made of HRP type metal and binded with tin. If extra strength is needed we also prefer silver instead.

Our company policy is to provide our customers with worldclass high quality products and constant innovation. Surucu products are manufactured to meet the highest standards of performance and efficiency. We provide an environment where customer's needs are analyzed and maximized by implementing practices of attachments and folders on real sewing machines. This methodology eliminate errors that may arise in practice. Customers play an important role in our strategies when achieving success and excellence and will continue to be our key focus when developing products.

Surucu aims % 100 percent customer satisfaction. To achieve this goal, we utilize high-tech machines, high-skilled workers and periodical research & development works. Customer's special needs are handled with care and attachments and folders for new garment designs can be innovated in a short time by our experts.

One of the keys to our success has been our ability to listen to our customers and react quickly and effectively to meet their needs. Acting on customer input is one of the key points playing important role in our success. Providing and managing the customer relationship is a company-wide task.

The long-term success of Surucu depends upon a deep understanding of textile industry needs and response it with satisfactory quality. Blending the best of Surucu's heritage with new attributes maintains and enhances our competitiveness in the market.

We rely on teamwork by providing a collaborative environment and make effort on finding new and better ways of reaching the best. Teamwork brings experience and good skills together in ways that help us continue raising the bar on our success. Surucu believes in fostering an environment where highly motivated, action-oriented employees work together to continuously output and deliver high-quality, innovative products and services.

Surucu has supplied many different leading textile companies up to now and exported to countries like Italy, France, Poland, Norway, Sweden, Lithuania, Latvia, Romania, India, Egypt.

As a member of KOSGEB and with ISO 9001: 2000 Quality Management Certificate, Surucu continues to grow worldwide by the combination of it's vision, mission, experience and know-how heritage. If you are looking for a reliable supplier, SURUCU is the right place.

We would be glad to serve you.

P 001

Giriş Cut Size mm	Çıkış Finish Size mm
70	25
85	30
95	38
100	40
110	42
120	45
125	50
135	55
145	60

70 25

85 30

95 38

100 40

110 42

120 45

125 50

135 55

145 60

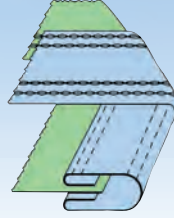

KOT KEMER APERESİ JEAN WAISTBAND ATTACHMENT



- 4 iğne kemer makinası ve 4 iğne lastik makinası için üretilmiştir.
- Kot pantolonların kemer ve kot montların kol ve etek kısımlarında kullanılır.
- Beden istenilen ölçüde kemer içine ayarlanabilir.
- Lastikli kemerlerde kapak değiştirilip, beden kemer içine kadar verilebilir.
- Kalın kot kumaşlar (XH) için üretilmiştir.

- Produced for 4 needles waistband machine and for 4 needles rubber machine.
- Used on the waistband parts of the jean trousers and on the sleeve and bottom parts of the jean jackets.
- The body can be adjusted in the waistband to the required size.
- On the rubber waistbands, the body can be placed into the waistband by changing the cover.
- Produced for heavy jean fabrics (XH).

Giriş Cut Size mm	Çıkış Finish Size mm
70	25
85	30
95	38
100	40
110	42
120	45
125	50
135	55
145	60

70 25

85 30

95 38

100 40

110 42

120 45

125 50

135 55

145 60

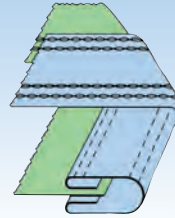

P 001A

OTOMAT KOT KEMER APERESİ AUTOMATIC WAISTBAND MACHINE ATTACHMENT FOR JEANS



- Otomat kemer makinaları için üretilmiştir.
- Kot pantolonların kemer kot montların kol ve etek kısımlarında kullanılır. Beden istenilen ölçüde kemer içine ayarlanabilir.
- Kalın kot kumaşlar için üretilmiştir.

- Produced for automatic waistband machines.
- Used for waistband parts of jean trousers, sleeves and hems of jean jackets.
- Produced for heavy jean fabrics (XH)

Giriş Cut Size mm	Çıkış Finish Size mm
70	25
85	30
95	38
100	40
110	42
120	45
125	50
135	55
145	60

70 25

85 30

95 38

100 40

110 42

120 45

125 50

135 55

145 60

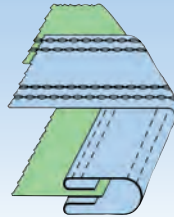

P 002

KOT KEMER APERESİ JEAN WAISTBAND ATTACHMENT



- 4 iğne kemer makinası ve 4 iğne lastik makinası için üretilmiştir.
- Kot pantolonların kemer ve kot montların kol ve etek kısımlarında kullanılır.
- Kalın kot kumaşlar (XH) için üretilmiştir.

- Produced for 4 needles waistband machines and for 4 needles rubber machines.
- Used on the waistband part of the jean trousers and on the sleeve and bottom parts of the jean jackets.
- Produced for heavy jean fabrics (XH).

P 003

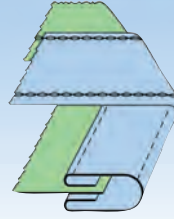

Giriş Cut Size mm	Çıkış Finish Size mm
70	25
85	30
95	35
100	38
110	40
125	50
135	55
145	60

KUMAŞ KEMER APERESİ FABRIC WAISTBAND ATTACHMENT



- 4 iğne kemer makinası ve 4 iğne lastik makinası için üretilmiştir.
- Kumaş, gabardin ve keten pantolonların kemer kısımları için kullanılır.
- Lastikli kemerlerde; kemere lastik eklenip kullanılabilir.
- Telalı kumaş, gabardin, keten ve ince kot kumaşlar için üretilmiştir.
- Produced for 4 needles waistband machine and for 4 needles rubber machine.
- Used on the waistband part of the fabric, gabardine and linen trousers.
- Can be used on the rubber waistbands by adding rubber to the waistband.
- Produced for fabrics with buckram, gabardine, linen and light jean fabrics.

P 003A

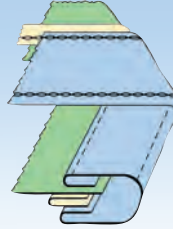

Arabiye Ornament Binding			
Giriş Cut Size mm	Çıkış Finish Size mm	Giriş Cut Size mm	Çıkış Finish Size mm
85	30	25	12
95	35		
100	38		
110	40	30	15
125	50		
135	55	35	17
145	60		

ARABİYELİ KUMAŞ KEMER APERESİ WAISTBAND ATTACHMENT WITH ORNAMENT BINDING FOR FABRICS



- 4 iğne kemer makinası ve 4 iğne lastik makinası için üretilmiştir.
- Kumaş, gabardin ve keten pantolonların kemer kısımları için kullanılır.
- Arabiye pantolon iç kısmında gözükür.
- Telalı kumaş gabardin, keten ve ince kumaşlar için üretilmiştir.
- Produced for 4 needles waistband machines and 4 needles elastic attaching machines.
- Used for waistband parts of trousers made of fabric, gabardine and linen.
- Ornament binding is seen in the inner part of the trousers.
- Produced for fabric gabardines with buckram, linen and light fabrics.

P 003B

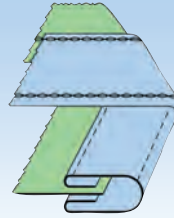

Giriş Cut Size mm	Çıkış Finish Size mm
70	25
85	30
95	35
100	38
110	40
125	50
135	55
145	60

OTOMAT KUMAŞ KEMER APERESİ AUTOMATIC WAISTBAND MACHINE ATTACHMENT FOR FABRICS



- Otomat kemer makinaları için üretilmiştir.
- Kumaş, gabardin ve keten pantolonların kemer kısımları için kullanılır.
- Telalı kumaş gabardin, keten ve ince kumaşlar için üretilmiştir.
- Produced for automatic waistband machines.
- Used for waistband parts of fabric, gabardine and linen trousers.
- Produced for fabric gabardines with buckram, linen and light fabrics.

Arabiye Ornament Binding			
Giriş Cut Size mm	Çıkış Finish Size mm	Giriş Cut Size mm	Çıkış Finish Size mm
85	30	25	12
95	35		
100	38		
110	40	30	15
125	50		
135	55		
145	60	35	17

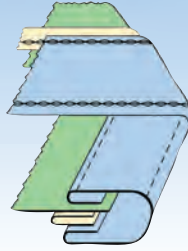

P 003C



OTOMAT ARABIYELİ KUMAŞ KEMER APERESİ AUTOMATIC WAISTBAND MACHINE FABRIC WAISTBAND WITH ORNAMENT BINDING ATTACHMENT

- Otomat kemer makinaları için üretilmiştir.
- Kumaş, gabardin ve keten pantolonların kemer kısımları için kullanılır.
- Arabiye pantolon iç kısmında gözükür.
- Telalı kumaş gabardin, keten ve ince kumaşlar için üretilmiştir.
- Produced for automatic waistband machines.
- Used for waistband parts of fabric, gabardine and linen trousers.
- Ornament binding is seen in the inner part of the trousers.
- Produced for fabric gabardines with buckram, linen and light fabrics.

Giriş Cut Size mm	Çıkış Finish Size mm
60	20
70	25
85	30
95	35
100	38
110	40

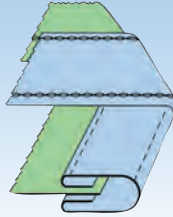

P 004



KAPALI KEMER APERESİ COVERED WAISTBAND ATTACHMENT

- 4 iğne kemer makinası ve 4 iğne lastik makinaları için üretilmiştir.
- Kumaş pantolonların kemer kısımları için kullanılır.
- Lastikli kemerlerde; kemere lastik ilave edip ya da apeareye gergi monte edip kullanılabilir.
- Çok ince kumaşlar (L) ve ince kumaşlar (M) için üretilmiştir.
- Produced for 4 needles waistband machines and for 4 needles rubber machines.
- Used for the waistband parts of fabric trousers.
- On the rubber waistbands, it can be used by adding rubber to the waistband or by mounting stretch to the attachment.
- Produced for very light (L) and light fabrics (M).

Giriş Cut Size mm	Çıkış Finish Size mm
65	25
80	30
90	35
95	38
100	40
105	40
110	40

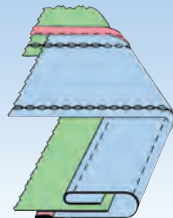

P 004A



ALTI AÇIK KAPALI KEMER APERESİ OPEN BOTTOM COVERED WAISTBAND ATTACHMENT

- 4 iğne kemer makinası ve 4 iğne lastik makinası için üretilmiştir.
- Kumaş, gabardin ve keten pantolonların kemer kısımları için kullanılır.
- Arabiye pantolon iç kısmında gözükür.
- Çok ince kumaşlar (L) ve ince kumaşlar (M) için üretilmiştir.
- Produced for 4 needles waistband machines and 4 needles elastic attaching machines.
- Used for waistband parts of trousers made of fabric, gabardine and linen.
- Ornament binding is seen in the inner part of the trousers.
- Produced for very light fabrics (L) and light fabrics (M).

P 005

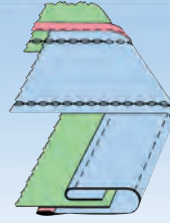

Giriş Cut Size mm	Çıkış Finish Size mm
65	25
80	30
90	35
95	38
105	40

ALTI AÇIK KEMER APERESİ OPEN BOTTOM WAISTBAND ATTACHMENT



- 4 iğne kemer makinası ve 4 iğne lastik makinaları için üretilmiştir.
- Kumaş, Gabardin ve keten pantolonların kemer kısımları için kullanılır.
- Orta kumaşlar (MH) ve orta kalın kumaşlar (H) için üretilmiştir.
- Produced for 4 needles waistband machines and for 4 needles rubber machines.
- Used on the waistband part of the fabric, gabardine and linen trousers.
- Produced for medium fabrics (MH) and medium heavy fabrics (H)

P 005A

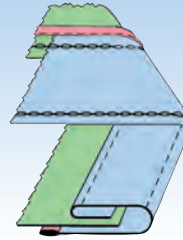

Giriş Cut Size mm	Çıkış Finish Size mm
65	25
80	30
90	35
95	38
105	40

OTOMAT ALTI AÇIK KEMER APERESİ AUTOMATIC WAISTBAND MACHINE OPEN BOTTOM WAISTBAND ATTACHMENT



- Otomat kemer makinaları için üretilmiştir.
- Kumaş, gabardin ve keten pantolonların kemer kısımları için kullanılır.
- Telahlı kumaş gabardin, keten ve ince kumaşlar için üretilmiştir.
- Produced for automatic waistband machines.
- Used for waistband parts of fabric, gabardine and linen trousers.
- Produced for fabric gabardines with buckram, linen and light fabrics.

P 006

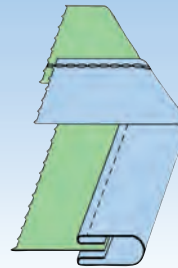

Giriş Cut Size mm	Çıkış Finish Size mm
45	12
50	14
50	15
55	18
60	20

KÜÇÜK KEMER APERESİ SMALL WAISTBAND ATTACHMENT



- 4 iğne kemer makinaları ve 4 iğne lastik makinaları için üretilmiştir.
- Bayan pantolonların kemerleri, kot montların etek kısımları ve bayan elbiselerin kuşakları için kullanılır.
- İnce kumaşlar (M), orta kumaşlar (MH) ve orta kalın kumaşlar (H) için üretilmiştir.
- Produced for 4 needles waistband machines and 4 needles rubber machines.
- Used for the waistbands of ladies trousers, the bottom part of the jean jackets and for the waistbands of ladies garments.
- Produced for the light (M), medium light (MH) and medium heavy (H) fabrics.

Giriş Cut Size mm	Çıkış Finish Size mm
55	18
60	20
70	25
85	30
95	35
100	40
110	42
120	45
125	50

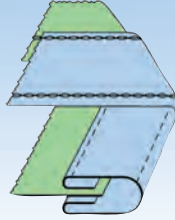

KEMER APERESİ WAISTBAND ATTACHMENT



- 4 iğne kemer makineleri, 4 iğne lastik makineleri ve press makineleri için üretilmiştir
- Kot pantolon kemerleri, kot montların kol ve etek kısımlarında kullanılır.
- Orta kalın kumaşlar (H), kalın kumaşlar (XH) ve Likralı kot kumaşlar için üretilmiştir.
- Produced for 4 needles waistband machines, 4 needles rubber machines and for press machines.
- Used on the trousers waistbands, on the sleeve and bottom parts of the jean jackets.
- Produced for medium heavy (H), heavy fabrics (XH) and for the jean fabrics with lycra.

Giriş Cut Size mm	Çıkış Finish Size mm
55	18
60	20
70	25
85	30
95	35
100	40
110	42
120	45
125	50

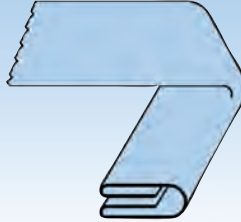

KEMER APERESİ WAISTBAND ATTACHMENT



- 4 iğne kemer makineleri, 4 iğne lastik makineleri ve press makineleri için üretilmiştir.
- Pantolon kemerleri, bayan kot elbiselerin kuşakları kot montların kol ve etek kısımları için kullanılır.
- Orta kalın kumaşlar (H), kalın kumaşlar (XH) ve Likralı kot kumaşlar için üretilmiştir.
- Produced for 4 needles waistband machines, 4 needles rubber machines and for press machines.
- Used for trousers waistbands, for the ladies jean garments' waistbands, for the sleeve and bottom parts of the jean jackets.
- Produced for medium heavy (H), heavy fabrics (XH) and for the jean fabrics with lycra.

Giriş Cut Size mm	Çıkış Finish Size mm
55	20
70	25
80	30
90	35
95	40
100	42
105	45

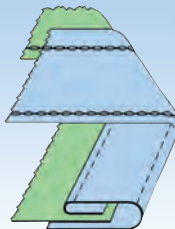

ALTI AÇIK KEMER APERESİ OPEN BOTTOM WAISTBAND ATTACHMENT



- 4 iğne kemer makinası, 4 iğne lastik makineleri ve pres makineleri için üretilmiştir.
- Kumaş, Gabardin ve keten pantolonların kemer kısımları için kullanılır.
- Orta kumaşlar (MH), orta kalın kumaşlar (H) ve likralı kot kumaşlar için üretilmiştir.
- Produced for 4 needles waistband machines, 4 needles rubber machines and for press machines.
- Used for the waistband parts of the fabric, gabardine and linen trousers.
- Produced for medium fabrics (MH), medium heavy fabrics (H) and jean fabrics with lycra (H)

P 010

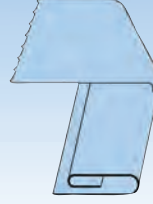

Giriş Cut Size mm	Çıkış Finish Size mm
55	20
70	25
80	30
90	35
95	40
100	42
105	45

ALTI AÇIK KEMER APERESİ OPEN BOTTOM WAISTBAND ATTACHMENT

- Press makinaları için üretilmiştir.
- Kumaş, gabardin, ve keten pantolonların kemer kısımları için kullanılır.
- Orta kumaşlar (MH), orta kalın kumaşlar (H) ve Likralı kot kumaşlar için üretilmiştir.
- Produced for press machines.
- Used for the waistband parts of the fabric, gabardine and linen trousers.
- Produced for medium fabrics (MH), medium heavy fabrics (H) and jean fabrics with lycra (H).

P 011

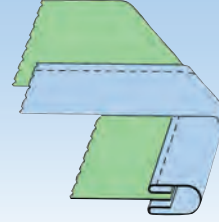

Giriş Cut Size mm	Çıkış Finish Size mm
60	20
70	25
85	30
90	32
95	35
100	38
110	40

ÇİFT İĞNE KEMER APERESİ DOUBLE NEEDLE WAISTBAND ATTACHMENT

- Çift iğne dikiş makinaları için üretilmiştir.
- Kumaş, gabardin, keten ve ince kot pantolonların kemerlerinde, gömleklerin ön patında, bayan elbiselerin kemerlerinde, montların kol ve etek kısımlarında kullanılır.
- İnce kumaşlar (M), orta kumaşlar (MH) ve orta kalın kumaşlar (H) için üretilir.
- Produced for double needle sewing machines.
- Used on the waistbands of fabric, gabardine, linen and light jean trousers, on the front band of the shirts, on the waistband of ladies garments, on the arm and bottom parts of the jackets.
- Produced for the light fabrics (M), medium light fabrics (MH) and medium heavy (H) fabrics.

P 012

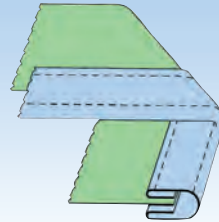

Giriş Cut Size mm	Çıkış Finish Size mm
35	10
40	10
40	12
45	13
45	14
50	15
50	16
55	18

KÜÇÜK ÇİFT İĞNE KEMER APERESİ SMALL DOUBLE NEEDLE WAISTBAND ATTACHMENT

- Çift iğne dikiş makinaları için üretilmiştir.
- Bayan pantolonların kemerleri, kot montların etek kısımları ve bayan elbiselerinin kuşakları için kullanılır.
- İnce kumaşlar (M), orta kumaşlar (MH) ve orta kalın kumaşlar (H) için üretilmiştir.
- Produced for double needle sewing machines.
- Used for waistbands of ladies trousers, bottom parts of jean jackets and belts of ladies garments.
- Produced for medium heavy (H), heavy fabrics (MH) and for the jean fabrics with lycra.

Kumaş Kalınlığı
Thick Material Size

XH

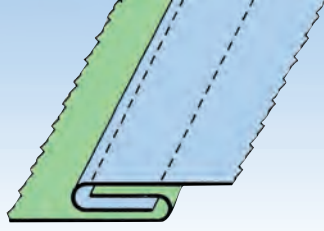

P 013A



AYARLI ÜÇ İĞNE KOLLU APERESİ SPRING TYPELAR SEAM FOLDER



- Brother ve Juki üç iğne kumlu makinaları için üretilir.
- Pantolonların bacak arası, conta ve arka ortalarını çatmada kullanılır.
- Kalın kot kumaşlar (XH) için üretilir.
- Produced for Brother and Juki three needles feed of the arm sewing machines.
- Used for connecting the leg intervals, seam and back centers of the trousers.
- Produced for heavy jean fabrics (XH).

Kumaş Kalınlığı
Thick Material Size

H

XH

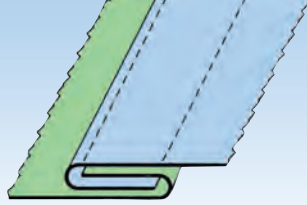

P 013B



GENİŞ KOLLU APERESİ WIDE SEAM FOLDER



- Brother ve Juki üç iğne kumlu makinaları için üretilir.
- Pantolonların bacak arası, conta ve arka ortalarını çatmada kullanılır.
- Dışli plaka ayak değişir,
- Kalın kot kumaşlar (XH), orta kalın kumaşlar (H) için üretilir.
- Produced for Brother and Juki three needles feed of the arm sewing machines.
- Used for connecting the leg intervals, seam and back centers of the trousers.
- Feed dog plate and foots can be changed.
- Produced for heavy jean fabrics (XH) and medium heavy fabrics (H).

Kumaş Kalınlığı
Thick Material Size

Ayarlı

Adjustable

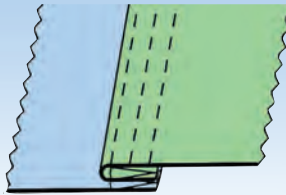

P 013C



ÜÇ İĞNE KOLLU SİPERİ SPRING TYPELAR GUARD PLATE



- Brother ve Juki üç iğne kumlu makinaları için üretilir.
- Pantolonların bacak arası, conta ve arka ortalarını çatmada kullanılır.
- Kalın kot kumaşlar (XH), orta kalın kumaşlar (H) için üretilir.
- Produced for Brother and Juki three needles feed of the arm sewing machines.
- Used for connecting the leg intervals, seam and back centers of the trousers.
- Produced for heavy jean fabrics (XH) and medium heavy fabrics (H).

P 013

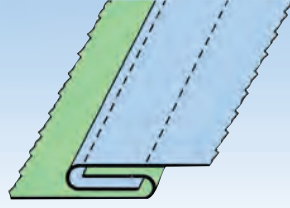
Kumaş Kalınlığı
Thick Material Size

XH

ÜÇ İĞNE KOLLU APERESİ SPRING TYPELAR SEAM FOLDER

- Brother ve Juki üç iğne kollu makinaları için üretilir.
- Pantolonların bacak arası, conta ve arka ortalarını çatmada kullanılır.
- Kalın kot kumaşlar (XH) için üretilir.



- Produced for Brother and Juki three needles feed of the arm sewing machines.
- Used for connecting the leg intervals, seam and back centers of the trousers.
- Produced for heavy jean fabrics (XH).

P 014

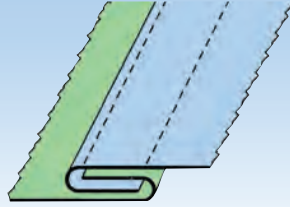
Kumaş Kalınlığı
Thick Material Size

H

ÜÇ İĞNE KOLLU APERESİ SPRING TYPELAR SEAM FOLDER

- Brother ve Juki üç iğne kollu makinaları için üretilir.
- Pantolonların bacak arası, conta ve arka ortalarını çatmada, çadır ve branda yapımında kullanılır.
- Orta kalın kumaşlar (H) için üretilir.



- Produced for Brother and Juki three needles feed of the arm sewing machines.
- Used for connecting the leg intervals, side and back centers of the trousers and for the production of tent and hammock (canvas).
- Produced for medium heavy fabrics (H).

P 014A

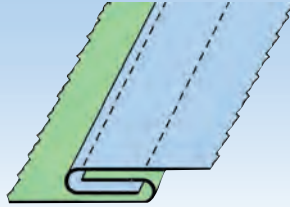
Kumaş Kalınlığı
Thick Material Size

MH

ÜÇ İĞNE KOLLU APERESİ SPRING TYPELAR SEAM FOLDER

- Brother ve Juki üç iğne kollu makinaları için üretilir.
- Pantolonların bacak arası, conta ve arka ortalarını çatmada, çadır ve branda yapımında kullanılır.
- Orta kumaşlar (MH) için üretilir.



- Produced for Brother and Juki three needles feed of the arm sewing machines.
- Used for connecting the leg intervals, side and back centers of the trousers and for the production of tent and hammock (canvas).
- Produced for medium light fabrics (MH).

Kumaş Kalınlığı
Thick Material Size

MH
H
XH

İğne Aralığı

1/8
3/16

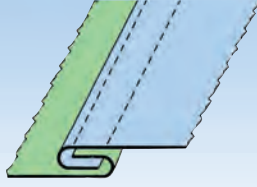

P 014B



DAR KOLLU APERESİ NARROW SEAM FOLDER



- Brother ve Juki iki iğne kollu makinaları için üretilmiştir.
- Pantolonların bacak arası conta ve arka ortaların çatmada kullanılır.
- Kot kumaşlar (XH), orta kalın kumaşlar (H) ve orta kumaşlar(MH) için üretilmiştir.

- Produced for Brother or Juki double needle feed of the arm sewing machines.
- Used for sewing center and back seams of the trousers.
- Produced for jean (XH), medium heavy (H) and medium (MH) fabrics.

Kumaş Kalınlığı
Thick Material Size

MH
H
XH

İğne Aralığı

1/4

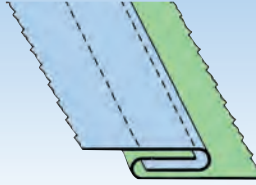

P 014C



TERS KOLLU APERESİ REVERSE SEAM FOLDER



- Brother ve Juki üç iğne kollu makinaları için üretilmiştir.
- Pantolonların bacak arası conta ve arka ortaların çatmada kullanılır.
- Kalın kot kumaşlar (XH), orta kalın kumaşlar (H) ve orta kumaşlar (MH) için üretilmiştir.

- Produced for Brother and Juki three needles feed of the arm sewing machines.
- Used for sewing center and back seams of the trousers.
- Produced for heavy (XH), medium heavy (H) and medium (MH) jean fabrics.

Kumaş Kalınlığı
Thick Material Size

M
MH
H
XH

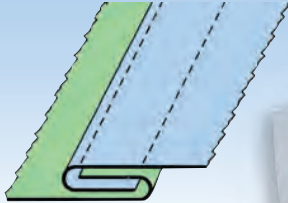

P 015



ZİNCİR DİKİŞ KOLLU APERESİ CHAIN STITCHING SEAM FOLDER



- Brother çift iğne zincir dikiş makinaları, Kansai Special üç iğne çift zincir dikiş makinaları ve Juki zincir dikiş makinaları için üretilmiştir.
- Pantolonların conta ve arka ortalarının çatılmasında kullanılır.
- İnce kumaş (M), orta kumaş (MH), orta kalın kumaş (H) ve kalın kumaşlar (XH) için üretilmiştir.

- Produced for Brother, double needle chain sewing machines, Kansai Special three needles double chain sewing machines and Juki chain sewing machines.
- Used for sewing seams and back centers of the trousers.
- Produced for light (M), medium light (MH), medium heavy (H) and heavy fabrics (XH).

P 016

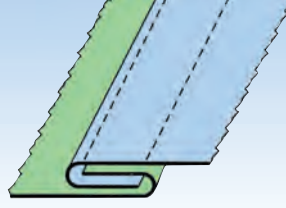

Kumaş Kalınlığı

Thick Material Size

M

MH

H

XH

UNION KOLLU APERESİ UNION SEAM FOLDER



- Union Special üç iğne kollu makinaları için üretilir.
- Pantolonların bacak arası, conta ve arka ortalarının çatılmasında kullanılır.
- İnce kumaş (M), orta kumaş (MH), orta kalın kumaş (H) ve kalın kumaşlar (XH) için üretilir.
- Produced for Union Special three needles feed of the arm sewing machines.
- Used for connecting the leg intervals, seam and back centers of the trousers.
- Produced for light (M), medium light (MH), medium heavy (H) and heavy fabrics (XH).

P 017

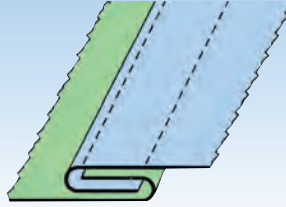

Kumaş Kalınlığı

Thick Material Size

M

MH

H

XH

PAFF KOLLU APERESİ PAFF SEAM FOLDER ARM



- Pfaff üç iğne zincir dikiş makinaları için üretilmiştir.
- Pantolonların conta ve arka ortalarının çatılmasında kullanılır.
- İnce kumaşlar (M), orta kumaşlar (MH), orta kalın kumaşlar (H) ve kalın kumaşlar (XH) için üretilmiştir.
- Produced for Pfaff three needles chain sewing machines.
- Used for connecting the side and back centers of the trousers.
- Produced for light fabric (M), medium light fabric (MH), medium heavy fabrics (H) and heavy fabrics (XH).

P 018

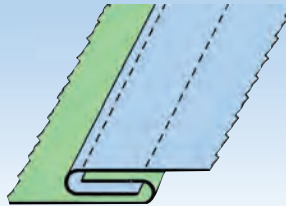

Kumaş Kalınlığı

Thick Material Size

M

MH

H

ÇİFT İĞNE ÇATMA APERESİ DOUBLE NEEDLE MACHINE ATTACHMENT WITH ARM



- Çift iğne dikiş makinaları için üretilir.
- Pantolonların conta ve arkalarını çatmada kullanılır.
- Çok ince kumaşlar (L), ince kumaşlar (M), orta kumaşlar (MH) ve orta kalın kumaşlar (H) üretilir.
- Produced for double needle sewing machines.
- Used for connecting the side and back centers of the trousers.
- Produced for very light (L), light (M) medium heavy (MH) and heavy fabrics (H).

Giriş Cut Size mm	Çıkış Finish Size mm
50	30
55	30
60	35
60	38
65	40
70	42
75	45
80	50

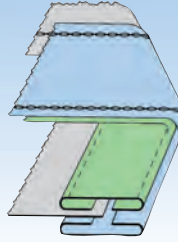

P 019

ALT ÜST KEMER APERESİ UP AND DOWN WAISTBAND ATTACHMENT



- 4 iğne kemer makinaları ve 4 iğne lastik makinaları için üretilmiştir.
- Pantolonların askı, kemer kısımlarında ve gömleklerin ön patlarında kullanılır.
- İnce kumaşlar (M), orta kumaşlar (MH), orta kalın kumaşlar (H) ve kalın kumaşlar (XH) için üretilir.
- Produced for 4 needles waistband machines and 4 needles rubber machines.
- Used on the hanger, waistband parts of the trousers and on the front band of the shirts.
- Produced for light (M), medium light (MH), medium heavy (H) and heavy fabrics (XH).

Giriş Cut Size mm	Çıkış Finish Size mm
50	30
60	35
70	42

Alt Apere Bottom Attachment
Ayarlı Adjustable

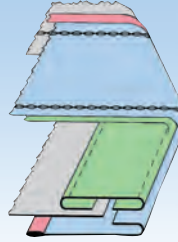

P 019A

ALTI BİYELİ ALT ÜST KEMER APERESİ UP AND DOWN WAISTBAND WITH BOTTOM PIPING ATTACHMENT



- 4 iğne kemer makinası ve 4 iğne lastik makinaları için üretilmiştir.
- Kumaş, Gabardin ve keten pantolonların kemer kısımları için kullanılır.
- Orta kumaşlar (MH) ve orta kalın kumaşlar (H) için üretilmiştir.
- Produced for 4 needles waistband machines and 4 needles rubber machines.
- Used on the waistband parts of fabric, gabardine and linen trousers.
- Produced for medium light (MH) and medium heavy fabrics (H).

Giriş Cut Size mm	Çıkış Finish Size mm
50	30
55	30
60	35
60	38
65	40
70	42
75	45
80	50

Alt Apere Bottom Attachment
Ayarlı Adjustable

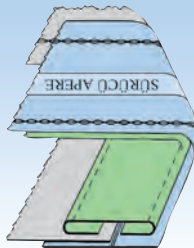

P 019B

KEMER ASTARLI ALT ÜST KEMER APERESİ UP AND DOWN WAISTBAND WITH LINING ATTACHMENT



- 4 iğne kemer makinası ve 4 iğne lastik makinaları için üretilmiştir.
- Kumaş, Gabardin ve keten pantolonların kemer kısımları için kullanılır.
- Orta kumaşlar (MH) ve orta kalın kumaşlar için üretilmiştir.
- Produced for 4 needles waistband machines and 4 needles elastic attaching machines.
- Used for waistband parts of trousers made of fabric, gabardine and linen.
- Produced for medium (MH) and medium heavy (H) fabrics.

P 019C

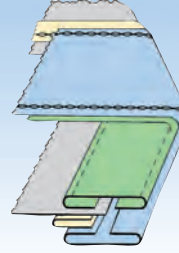

Arabiye Ornament Binding			
Giriş Cut Size mm	Çıkış Finish Size mm	Giriş Cut Size mm	Çıkış Finish Size mm
50	30		
55	30	25	12
60	35		
60	38	30	15
65	40		
70	42	35	17
75	45		
80	50		

ARABİYELİ ALT ÜST KEMER APERESİ

UP AND DOWN WAISTBAND WITH ORNAMENT BINDING ATTACHMENT

- 4 iğne kemer makinası ve 4 iğne lastik makinası için üretilmiştir.
- Kumaş, gabardin ve keten pantolonların kemer kısımları için kullanılır.
- Arabiye pantolon iç kısmında gözüktür.
- Telalı kumaş gabardin, keten ve ince kumaşlar için üretilmiştir.
- Produced for 4 needles waistband machines and 4 needles elastic attaching machines.
- Used for waistband parts of trousers made of fabric, gabardine and linen.
- Ornament binding is seen in the inner part of the trousers.
- Produced for fabric gabardines with buckram, linen and light fabrics.



P 019D

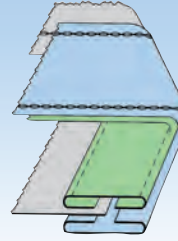

Arabiye Ornament Binding	
Giriş Cut Size mm	Çıkış Finish Size mm
50	30
55	30
60	35
60	38
65	40
70	42
75	45
80	50

OTOMAT ALT ÜST KEMER APERESİ

AUTOMATIC WAISTBAND MACHINE UP AND DOWN WAISTBAND ATTACHMENT

- Otomat kemer makinaları için üretilmiştir.
- Kumaş, gabardin ve keten pantolonların kemer kısımları için kullanılır.
- Telalı kumaş gabardin, keten ve ince kumaşlar için üretilmiştir.
- Produced for automatic waistband machines.
- Used for waistband parts of trousers made of fabric, gabardine and linen.
- Produced for fabric gabardines with buckram, linen and light fabrics.



P 019E

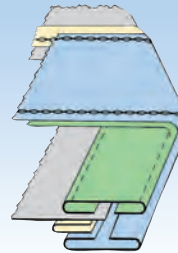

Arabiye Ornament Binding			
Giriş Cut Size mm	Çıkış Finish Size mm	Giriş Cut Size mm	Çıkış Finish Size mm
50	30		
55	30	25	12
60	35		
60	38	30	15
65	40		
70	42	35	17
75	45		
80	50		

ARABİYELİ OTOMAT ALT ÜST KEMER APERESİ

AUTOMATIC WAISTBAND MACHINE UP AND DOWN WAISTBAND WITH ORNAMENT BINDING ATTACHMENT

- Otomat kemer makinaları için üretilmiştir.
- Kumaş, gabardin ve keten pantolonların kemer kısımları için kullanılır.
- Arabiye pantolon iç kısmında gözüktür.
- Telalı kumaş gabardin, keten ve ince kumaşlar için üretilmiştir.
- Produced for automatic waistband machines.
- Used for waistband parts of trousers made of fabric, gabardine and linen.
- Ornament binding is seen in the inner part of the trousers.
- Produced for fabric gabardines with buckram, linen and light fabrics.



Giriş Cut Size mm	Çıkış Finish Size mm
60	30
65	36
70	42
75	45
80	50
85	55
90	60
100	70

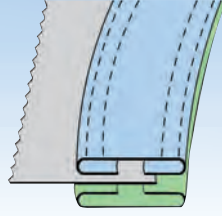

P 020

KAVİSLİ ALT ÜST KEMER APERESİ CURVED UP AND DOWN WAISTBAND ATTACHMENT



- 4 iğne kemer makinaları ve 4 iğne lastik makinaları için üretilmiştir.
- Pantolonların kemer kısımlarında kullanılır.
- İnce kumaşlar (M), orta kumaşlar (MH), orta kalın kumaşlar (H) ve kalın kumaşlar (XH) için üretilmiştir.
- Produced for 4 needles waistband machines and 4 needles rubber machines.
- Used on the waistband parts of the trousers.
- Produced for light (M), medium light (MH), medium heavy (H) and heavy fabrics (XH).

Giriş Cut Size mm	Çıkış Finish Size mm
60	30
65	36
70	42
75	45
80	50
85	55
90	60
100	70

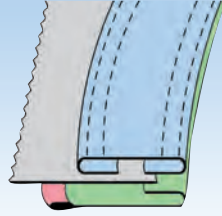

P 020A

ALT BİYELİ KAVİSLİ ALT ÜST KEMER APERESİ CURVED UP AND DOWN WAISTBAND WITH BOTTOM PIPING ATTACHMENT



- 4 iğne kemer makinaları ve 4 iğne lastik makinaları için üretilmiştir.
- Pantolonların kemer kısımlarında kullanılır.
- İnce kumaşlar (M), orta kumaşlar (MH), orta kalın kumaşlar (H) ve kalın kumaşlar (XH) için üretilmiştir.
- Produced for 4 needles waistband machines and 4 needles rubber machines.
- Used on the waistband parts of the trousers.
- Produced for light (M), medium light (MH), medium heavy (H) and heavy fabrics (XH).

		Arabiyeli Ornament Binding	
Giriş Cut Size mm	Çıkış Finish Size mm	Giriş Cut Size mm	Çıkış Finish Size mm
60	30		
65	36	25	12
70	42		
75	45	30	15
80	50		
85	55	35	17
90	60		
100	70		

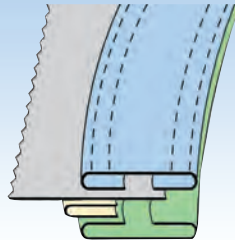

P 020B

ARABİYELİ KAVİSLİ ALT ÜST KEMER APERESİ CURVED WAISTBAND ATTACHMENT WITH ORNAMENT BINDING ATTACHMENT



- 4 iğne kemer makinası ve 4 iğne lastik makinası için üretilmiştir.
- Pantolonların kemer kısımları için kullanılır.
- Arabiyeli pantolon iç kısmında gözükür.
- Produced for 4 needles waistband machines and 4 needles elastic attaching machines.
- Used for waistband parts of trousers.
- Ornament binding is seen in the inner part of the trousers.

P 021

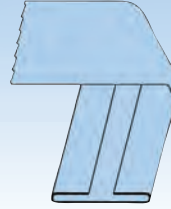

PRESS KEMER KIRIM APERESİ PRESS ATTACHMENT FOR WAISTBAND FOLDING

- Press makinaları için üretilir.
- Pantolonların kemer kısımlarında kullanılır.
- İnce kumaşlar (M) orta kumaşlar (MH), orta kalın kumaşlar (H), kalın kumaşlar (XH) ve Likralı kumaşlar için üretilmiştir.
- Produced for press machines.
- Used on the waistband parts of the trousers.
- Produced for light fabric (M), medium light (MH), medium heavy (H) and heavy fabrics (XH) and for the fabrics with lycra.

Giriş Cut Size mm	Çıkış Finish Size mm
40	20
40	22
45	25
45	28
50	30
55	30
60	35
60	38
65	40
70	40
70	42

P 022

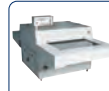

PRESS KAVİSLİ KEMER KIRIM APERESİ CURVED PRESS ATTACHMENT FOR WAISTBAND FOLDING

- Press makinaları için üretilmiştir.
- Pantolonların kemer kısımlarında kullanılır.
- İnce kumaşlar (M), orta kumaşlar (MH), orta kalın kumaşlar (H), kalın kumaşlar (XH) ve Likralı kumaşlar için üretilmiştir.
- Produced for press machines.
- Used on the waistband parts of the trousers.
- Produced for light fabric (M), medium light (MH), medium heavy (H) and heavy fabrics (XH) and for the fabrics with lycra.

Giriş Cut Size mm	Çıkış Finish Size mm
42	20
45	22
50	25
55	28
60	30
65	35
70	38
70	40
70	42
80	50

P 023

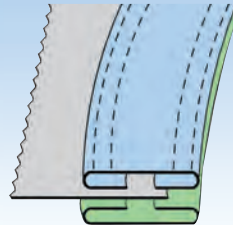
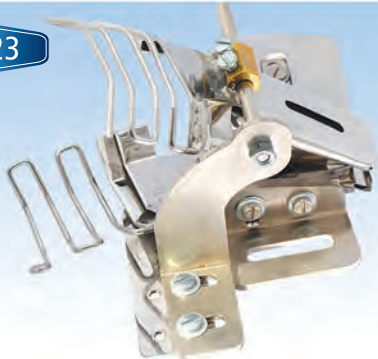

OTOMAT ALT ÜST KAVİSLİ KEMER APERESİ UP AND DOWN WAISTBAND ATTACHMENT FOR SINGER MACHINE

- Singer 4 iğne kemer makinası için üretilir.
- Pantolonların kemer kısımlarında kullanılır.
- İnce kumaşlar (M), orta kumaşlar (MH), orta kalın kumaşlar (H) ve kalın kumaşlar (XH) için üretilir.
- Produced for Singer 4 needles waistband machines.
- Used on the waistband parts of the trousers.
- Produced for light (M), medium light (MH), medium heavy (H) and heavy fabrics (XH).



Giriş Cut Size mm	Çıkış Finish Size mm
60	30
65	36
70	42
75	45
80	50
85	55
90	60
100	70

Altı Apered
Bottom Attachment

Giriş Cut Size mm	Çıkış Finish Size mm	Giriş Cut Size mm	Çıkış Finish Size mm
60	30	55	40
65	36	60	45
70	42	65	50
75	45	70	55
80	50	75	60
85	55		
90	60		
100	70		

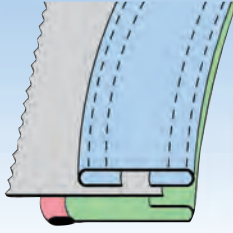

P 023A

OTOMAT ALTI AÇIK ALT ÜST KAVİSLİ KEMER APERESİ AUTOMATIC WAISTBAND MACHINE OPEN BOTTOM UP AND DOWN WAISTBAND ATTACHMENT

- Otomat kemer makinaları için üretilmiştir.
- Pantolonların kemer kısımları için kullanılır.
- İnce kumaşlar (M), orta kumaşlar (MH), orta kalın kumaşlar (H) ve kalın kumaşlar (XH) için üretilmiştir.
- Produced for automatic waistband machines.
- Used for waistband parts of trousers.
- Ornament binding is seen in the inner part of the trousers.
- Produced for light (M), medium (MH), heavy medium (H) and heavy fabrics (XH).



Altı Apered
Bottom Attachment

Giriş Cut Size mm	Çıkış Finish Size mm	Giriş Cut Size mm	Çıkış Finish Size mm
60	30	55	40
65	36	60	45
70	42	65	50
75	45	70	55
80	50	75	60
85	55		
90	60		
100	70		

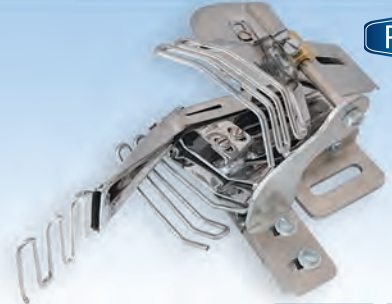
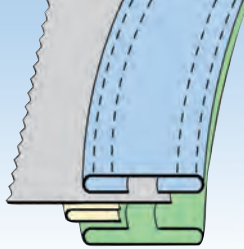

P 023B

OTOMAT ARABİYELİ ALT ÜST KAVİSLİ KEMER APERESİ AUTOMATIC WAISTBAND MACHINE UP AND DOWN CURVED WAISTBAND ATTACHMENT

- Otomat kemer makinaları için üretilmiştir.
- Pantolonların kemer kısımları için kullanılır.
- Arabiye pantolon iç kısmında gözükür.
- İnce kumaşlar (M), orta kumaşlar (MH), orta kalın kumaşlar (H) ve kalın kumaşlar (XH) için üretilmiştir.
- Produced for automatic waistband machines.
- Used for waistband parts of trousers.
- Ornament binding is seen in the inner part of the trousers.
- Produced for light (M), medium (MH), heavy medium (H) and heavy fabrics (XH).



Çıkış
Finish
Size
mm

12
15

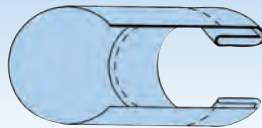

P 024

BORU PAÇA APERESİ TUBE BOTTOM ATTACHMENT

- Otomatik Paça dikme makinaları için üretilmiştir.
- Pantolonların boru tip paçalarını kıvrımda kullanılır.
- Orta kalın kumaşlar (H) ve kalın kumaşlar (XH) için üretilir.
- Hava tertibatı gerekmektedir.
- Produced for automatic hemming trousers and sleeves sewing machines.
- Used on the folding of the tube type bottoms of the trousers.
- Produced for medium heavy (H) and heavy fabrics (XH).
- Air system is necessary.



P 024A

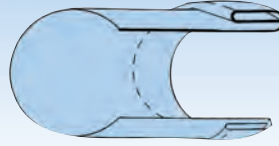

Çiğış
Finish
Size
mm

12

15

TERS BORU PAÇA APERESİ REVERSE TUBE BOTTOM ATTACHMENT

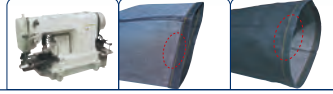

- Otomatik Paça dikme makinaları için üretilmiştir.
- Pantolonların boru tip paçalarını kıvrımda kullanılır.
- Orta kalın kumaşlar (H) ve kalın kumaşlar (XH) için üretilir.
- Hava tertibatı gerekmektedir.

- Produced for automatic hemming sewing machines.
- Used on the folding of the tube type bottoms of the trousers.
- Produced for medium heavy fabrics (H) and heavy fabrics (XH).
- Air system is necessary.

P 025

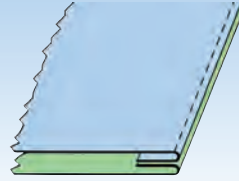

PATLET APERESİ PATLET ATTACHMENT



- Düz dikiş makinaları ve çift iğne dikiş makinaları için üretilmiştir.
- Pantolonların ön patletlerinde ve geniş kemerlerin uç kanatlarının kıvrılmasında kullanılır.
- Her türlü kumaş için üretilir.

- Produced for lockstitch sewing machines and double needle sewing machines.
- Used on the front patlets of the trousers and on the folding of the ends wings of the large waistbands.
- Produced for all kinds of fabrics.

P 026

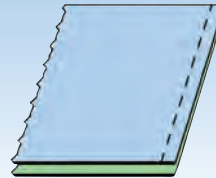

SİPER SHIELD



- Düz dikiş makinaları ve overlok makinaları için üretilmiştir.
- Pantolonların yan taraflarını birleştirmede kullanılır.
- Her türlü kumaş için üretilir.

- Produced for the lockstitch sewing machines and for the overlock machines.
- Used to connect the sides of the trousers
- Produced for all kinds of fabrics.

P 026A

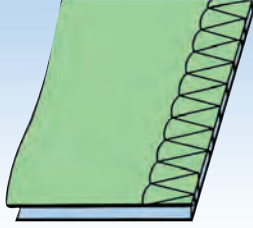

OVERLOK SİPERİ SHIELD FOR OVERLOCK



- Overlok makinaları için üretilmiştir
- Pantolonların yan taraflarını birleştirmek için kullanılır.
- Her türlü kumaş için üretilir.

- Produced for overlock machines
- Used to connect the sides of the trousers
- Produced for all kinds of fabrics.

Giris Cut Size mm	Çıkış Finish Size mm
28	12
30	13
35	15
38	17
42	18

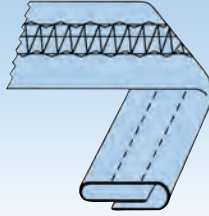

P 027



KOT KÖPRÜ APERESİ JEAN BELT LOOP FOLDER



- Bıçaklı köprü makinaları için üretilmiştir.
- Köprüler pantolonların kemer kısımlarında kullanılır.
- Ape kumaşın alt kısımlarında üst üste binmesini sağlayarak yıkama sonrası patlak yapmasını önler.
- Kalın kot kumaşlar (XH) için üretilmiştir.

- Produced for belt-loop machines with knife.
- Belt loops are used on the waistband parts of the trousers.
- The attachment will ensure the fabric to bind on the bottom parts, so the holes will be avoided after wash.
- Produced for heavy jean fabrics (XH).

Giris Cut Size mm	Çıkış Finish Size mm
25	10
28	12
30	13
35	15

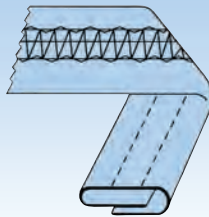

P 027A



KUMAŞ KÖPRÜ APERESİ FABRIC BELT LOOP FOLDER



- Bıçaklı köprü makinaları için üretilmiştir.
- Köprüler pantolonların kemer kısımlarında kullanılır.
- Ape kumaşın alt kısımlarında üst üste binmesini sağlayarak yıkama sonrası patlak yapmasını önler.
- Orta kalın kumaşlar (H) için üretilmiştir.

- Produced for belt-loop machines with knife.
- Belt loop are used on the waistband parts of the trousers.
- The attachment will ensure the fabric to bind on the bottom parts, so the holes will be avoided after wash.
- Produced for medium heavy fabric (H).

P 028

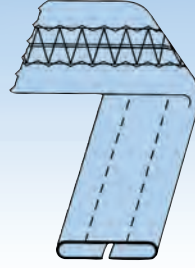
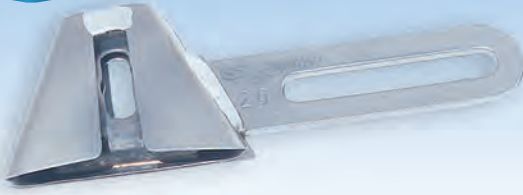

Giriş Cut Size mm	Çıkış Finish Size mm
22	10
26	12
32	15
38	18
42	20

UÇ UCA KÖPRÜ APERESİ BELT LOOP FOLDER END TO END



- Bıçaklı köprü makinaları için üretilmiştir.
- Köprüler pantolonların kemer kısımlarında kullanılır.
- Kumaşlara yapışkanlı tela eklenerek köprülerin patlak yapması önlenir.
- Produced for belt loop machines with knife.
- Belt loop are used on the waistband parts of the trousers.
- By adding sticking adhesive buckram to belt-loop fabric, the holes made by the belt loops are prevented.

P 029

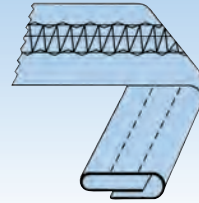

Giriş Cut Size mm	Çıkış Finish Size mm
20	8
25	10

REÇME MAKİNASI KÖPRÜ APERESİ BELT LOOP FOLDER ATTACHMENT FOR INTERLOCK MACHINES



- Reçme etek makinaları için üretilmiştir.
- Köprüler pantolonların kemer kısımlarında monte edilir.
- İnce kumaşlar (M), orta kumaşlar, (MH) ve orta kalın kumaşlar (H) için üretilmiştir.
- 1.8 cm.'den geniş köprülerde tercih edilen modeldir.
- Produced for plain seaming machines.
- Belt loops are mounted to the waistband parts of the trousers.
- Produced for light (M), medium (MH) and medium heavy fabrics (H).
- This is the type preferred for belt loops larger than 1.8 cm.

P 030

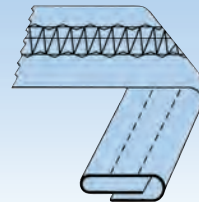

Giriş Cut Size mm	Çıkış Finish Size mm
28	12
30	13
35	15
38	16
41	18
45	20
48	22
55	25
60	28
65	30

REÇME MAKİNASI İNCE KUMAŞ KÖPRÜ APERESİ LIGHT FABRIC BELT LOOP FOLDER FOR INTERLOCK MACHINES



- Reçme etek makinaları için üretilmiştir.
- Köprüler pantolonların kemer kısımlarına monte edilir.
- Çok ince kumaşlar (L) ve ince kumaşlar (M) için üretilir.
- Aparente ince kumaşların alt kısımlarında üst üste binmesini sağlayarak, yıkama sonrası patlak yapmasını önlenir.
- Produced for plain seaming interlock machines.
- Belt loops are mounted to the waistband parts of the trousers.
- Produced for very light fabrics (L) and light fabrics (M).
- The attachment will ensure the light fabric to bind on the bottom parts, so the holes will be avoided after wash.

Giriş Cut Size mm	Çıkış Finish Size mm
24	8
28	10

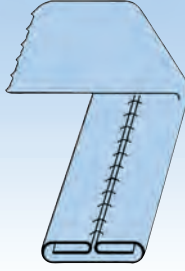

P 031

ETEK BASKI KÖPRÜ APERESİ BLINDSTITCH BELT LOOP FOLDER

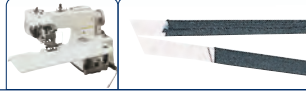

- Etek baskı makinaları için üretilmiştir.
- Köprüler pantolonların kemer kısımlarına monte edilir.
- Çok ince kumaşlar (L), ince kumaşlar (M), ve orta kumaşlar (MH) için üretilir.
- Produced for blindstitch belt-loop machines.
- Belt loops are mounted to waistband parts of the trousers.
- Produced for very light fabrics (L) and light fabrics (M) and medium fabrics (MH).

Giriş Cut Size mm	Çıkış Finish Size mm
25	10
28	12
30	13
35	15
38	17
45	20

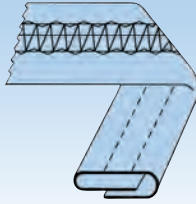

P 032

JUKİ MAKİNASI KÖPRÜ APERESİ BELT LOOP FOLDER (JUKİ)



- Juki bıçaklı köprü makinaları için üretilir.
- Köprüler pantolonların kemer kısımlarında monte edilir.
- İnce kumaşlar (M), orta kumaşlar (MH), orta kalın kumaşlar (H) ve kalın kumaşlar için üretilir.
- Apara kumaşın alt kısımlarında üst üste bindirmesi sağlayıp patlak yapmasını önler.
- Produced for Juki belt-loop machines with knife.
- Belt loops are mounted to waistband parts of the trousers.
- Produced for light fabrics (M), medium fabrics (MH) and medium heavy fabrics (H).
- The attachment will ensure the fabric to not bind on the bottom parts, so the holes will be avoided.

Giriş Cut Size mm	Çıkış Finish Size mm
22	10

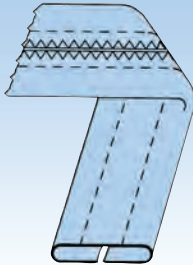

P 033

ÇİFT İĞNE MAKİNASI KÖPRÜ APERESİ DOUBLE NEEDLE BELT LOOP FOLDER

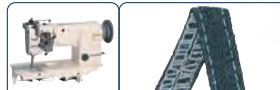

- Çift iğne dikiş makinaları için üretilmiştir.
- Köprüler pantolonların kemer kısımlarına monte edilir.
- İnce kumaşlar (M), orta kumaşlar (MH), orta kalın kumaşlar (H) ve kalın kumaşlar (XH) için üretilmiştir.
- Produced for double needle sewing machines.
- Belt loops are mounted to waistband parts of the trousers.
- Produced for light (M), medium (MH) medium heavy (H) and heavy fabrics (XH).

P 034

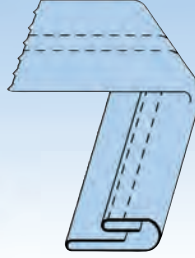
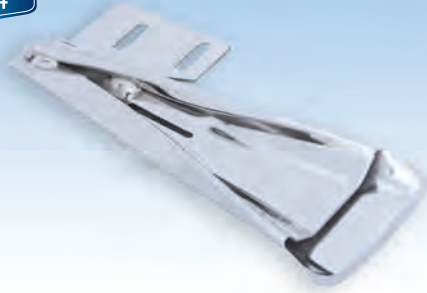

Giriş Cut Size mm	Çıkış Finish Size mm
30	10
35	12
40	13
45	15
50	17
60	20
65	20
80	25
95	30

ÇİFT İĞNE MAKİNASI ASKI APERESİ DOUBLE NEEDLE HANGER ATTACHMENT



- Çift iğne dikiş makinaları ve zincir dikiş makinaları için üretilmiştir.
- Bahçıvan tip pantolonların askılıklarında ve komando tip pantolonların cep yanına aksesuar olarak kullanılır.
- Orta kumaşlar (MH), orta kalın kumaşlar (H) ve kalın kumaşlar için üretilmiştir.
- Produced for double needle sewing machines and chain sewing machines.
- Used as accessory on the hangers of gardener type trousers and besides the pockets of the commando type trousers.
- Produced for the medium (MH), medium heavy (H) and heavy fabrics (XH)

P 034A

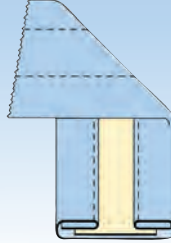

Giriş Cut Size mm	Çıkış Finish Size mm
80	20
85	22
90	25

ÇİFT İĞNE MAKİNASI ŞERİTLİ ASKI APERESİ DOUBLE NEEDLE HANGER WITH INTERLOCK ATTACHMENT



- Çift iğne dikiş makinaları için üretilmiştir.
- Bahçıvan tip pantolonların askılıklarında ve komando tip pantolonların cep yanına aksesuar olarak kullanılır.
- Orta kumaşlar (MH), orta kalın kumaşlar (H) ve kalın kumaşlar için üretilmiştir.
- Produced for double needle sewing machines.
- Used as accessory on the hangers of gardener type trousers and besides the pockets of the commando type trousers.
- Produced for the medium (MH), medium heavy (H) and heavy fabrics (XH)

P 034B

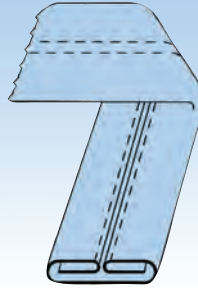

Giriş Cut Size mm	Çıkış Finish Size mm
27	10
33	12
42	15
51	18
57	20

ÇİFT İĞNE MAKİNASI ÖPÜŞMELİ KÖPRÜ APERESİ DOUBLE NEEDLE MACHINE SIDE BY SIDE LOOP ATTACHMENT



- Çift iğne dikiş makinaları için üretilmiştir.
- Bahçıvan tip pantolonların askılıklarında ve komando tip pantolonların cep yanına aksesuar olarak kullanılır.
- Orta kumaşlar (MH), orta kalın kumaşlar (H) ve kalın kumaşlar (XH) için üretilmiştir.
- Produced for double needle sewing machines.
- Used for brace parts of gardener trousers and near of pockets of commando trousers as a kind of ornament.
- Produced for medium (MH), heavy medium (H) and heavy fabrics (XH).

Giriş Cut Size mm		Çıkış Finish Size mm		Alt Aperesi Bottom Attachment	
15	6	22	10		
18	8	24	12		
22	10	28	14		
24	12	32	16		
28	14	40	20		
32	16	45	22		
		50	25		

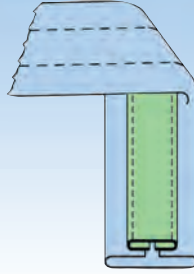

P 034C

ALT ÜST ÇİFT İĞNE KÖPRÜ APERESİ DOUBLE NEEDLE UP AND DOWN LOOP FOLDER

- Çift iğne dikiş makinaları için üretilmiştir.
- Bahçivan tip pantolonların askılıklarında ve komando tip pantolonların cep yanına aksesuar olarak kullanılır.
- Orta kumaşlar (MH), orta kalın kumaşlar (H) ve kalın kumaşlar (XH) için üretilmiştir.
- Produced for double needle sewing machines.
- Used for brace parts of gardener trousers and near of pockets of commando trousers as a kind of ornament.
- Produced for medium (MH), heavy medium (H) and heavy fabrics (XH).



Giriş Cut Size mm	Çıkış Finish Size mm
50	30
55	30
60	35
60	38
65	40
70	42

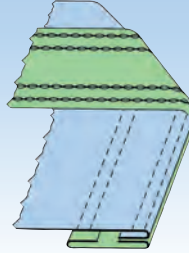

P 035

KİTİL APERESİ KITIL ATTACHMENT

- 4 iğne kemer makinaları, 4 iğne lastik makinaları ve çift iğne dikiş makinaları için üretilir.
- Pantolonların kemer, gömleklerin ön pat kısımlarında kullanılır.
- İstenilen kumaşa göre üretilir.
- Produced for 4 needles waistband machines, 4 needles rubber machines and double needle sewing machines.
- Used on the waistband part of the trousers and on the front band of the shirts.
- Produced according to the fabric to be used.



Giriş Cut Size mm	Çıkış Finish Size mm
65	36
70	42
75	45
80	50

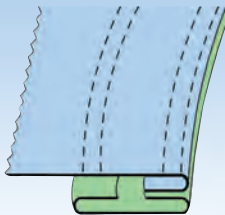

P 035A

KAVİSLİ KİTİL APERESİ CURVED KITIL ATTACHMENT

- 4 iğne kemer makinaları, 4 iğne lastik makinaları ve çift iğne dikiş makinaları için üretilir.
- Pantolonların kemer kısımlarında kullanılır.
- İstenilen kumaşa göre üretilir.
- Produced for 4 needles waistband machines, 4 needles rubber machines and double needle sewing machines.
- Used on the waistband part of the trousers and on the front band of the shirts.
- Produced according to the fabric to be used.



P 036

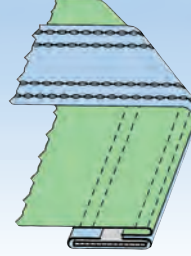

Giriş Cut Size mm	Çıkış Finish Size mm
50	30
55	30
60	35
60	38
65	40
70	42

LASTİKLİ KİTİL APERESİ KITIL ATTACHMENT WITH RUBBER

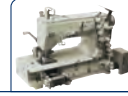

- 4 iğne kemer makinaları ve 4 iğne lastik makinaları için üretilir.
- Pantolonların (özellikle çocuk) kemer kısımlarında kullanılır.
- Orta kumaşlar (MH), orta kalın kumaşlar (H) üretilir.

- Produced for 4 needles waistband machines, 4 needles rubber machines.
- Used on the waistband parts (especially children) of the trousers.
- Produced for medium (MH) and medium heavy fabrics (H).

P 037

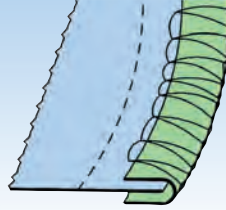

Giriş Cut Size mm	Çıkış Finish Size mm
10	5
12	6
15	7.5

CEP TORBASİ İKİYE KATLAMA APERESİ ATTACHMENT FOR FOLDING THE POCKET BAG INTO TWO

- 5 iplik overlok makinaları için üretilmiştir.
- Pantolon cep torbası kısımlarında kullanılır.
- Tül biyeler için üretilir.

- Produced for 5 threads overlock machines.
- Used on trousers pocket bags parts.
- Produced for tulle bindings



P 038

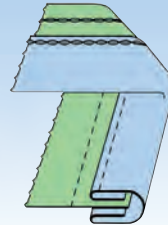

Giriş Cut Size mm	Çıkış Finish Size mm
20	5
25	6
28	7
30	8

CEP TORBASİ DÖRDE KATLAMA APERESİ ATTACHMENT FOR FOLDING THE POCKET BAG INTO FOUR

- Siruba, Kintex 4 iplik Overlok makinaları için üretilir.
- Pantolon cep torbası kısımlarında kullanılır.
- Tülbiye ve çok ince kumaşlar (M) için üretilir.

- Produced for Siruba, Kintex 4 treads overlock machines.
- Used on trousers pocket bags parts.
- Produced for tulle bindings and very light fabrics (M).



Giriş Cut Size mm	Çıkış Finish Size mm
22	10
24	12

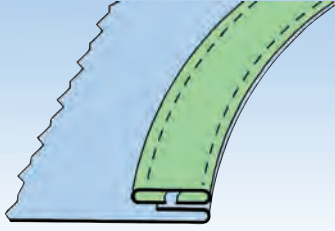

P 039

ÖN CEP AĞZI APERESİ FRONT POCKET OPENING ATTACHMENT



- Çift iğne dikiş makinaları için üretilmiştir.
- Pantolonların ön ceplerini yapmada kullanılır.
- Kumaş kalınlığı apareye göre standarttır.

- Produced for double needle sewing machines.
- Used for sewing the front pockets of the trousers.
- Fabric thickness is standard as per the attachment.

Kumaş Kalınlığı Thick Material Size	Çıkış Finish Size mm
H	10
XH	12

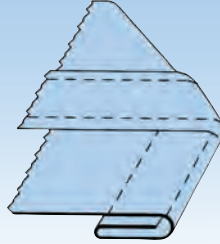

P 040

ARKA CEP AĞZI APERESİ BACK POCKET OPENING ATTACHMENT



- Çift iğne dikiş makinaları, zincir dikiş makinaları ve kollu makinaları için üretilir.
- Pantolonların arka ceplerinin üst taraflarını kıvrımda kullanılır.
- Orta kalın kumaşlar (H) ve kalın kumaşlar (XH) için üretilir.

- Produced for double needle sewing machines, chain sewing machines and machines with arm.
- Used to fold the upper parts of the back pockets of trousers.
- Produced for medium heavy (H) and heavy fabrics (XH).

Kumaş Kalınlığı Thick Material Size	Çıkış Finish Size mm
MHH	8
	10
XH	12

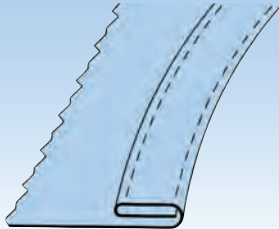

P 041

CEP AĞZI KIVIRMA APERESİ POCKET OPENING ATTACHMENT



- Çift iğne dikiş makinaları ve zincir dikiş makinaları için üretilmiştir.
- Pantolonların ön ceplerinde, arka ceplerinin üst kısımlarında, kot gömleklerin etek kısımlarında kullanılır.
- Orta kumaşlar (MH), orta kalın kumaşlar (H) ve kalın kumaşlar (XH) için üretilir.

- Produced for double needle sewing machines and chain sewing machines.
- Used on the front pockets of the trousers, on the upper parts of the back pockets, on the bottom parts of the jean shirts.
- Produced for the medium (MH), medium heavy (H) and heavy fabrics (XH).

P 042

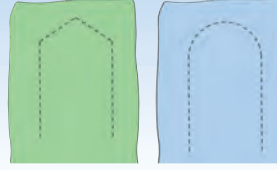
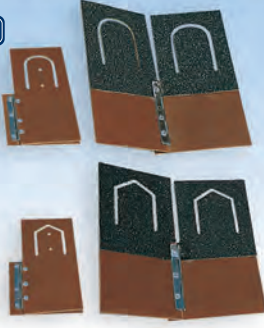
Çıkaş
Finish
Size
mm

35

40

45

PANTOLON DİL APERESİ TROUSER BAND ATTACHMENT



- Düz Dikiş Makinaları için üretilmiştir.
- Kumaş pantolonların dil kısımlarında kullanılır.
- Çok ince kumaşlar (L), ince kumaşlar (M) ve orta kumaşlar (MH) için üretilmiştir.
- Produced for lockstitch sewing machines.
- Used on the band parts of the fabric trousers.
- Produced for very light (L), light (M) and medium fabrics (MH).

P 042B

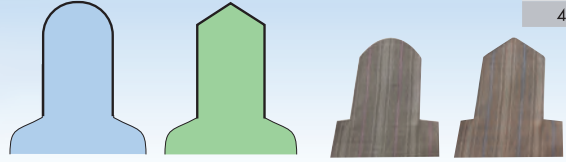
Çıkaş
Finish
Size
mm

35

40

45

BIÇAKLI DÜZ MAKİNA PANTOLON DİL APERESİ TROUSER BAND ATTACHMENT FOR LOCKSTITCH MACHINES WITH KNIFE



- Otomatik Düz Dikiş Makinaları için üretilmiştir.
- Kumaş pantolonların dil kısımlarında kullanılır.
- Çok ince kumaşlar (L), ince kumaşlar (M) ve orta kumaşlar (MH) için üretilmiştir.
- Produced for lockstitch auto sewing machines with.
- Used on the band parts of the fabric trousers.
- Produced for very light (L), light (M) and medium fabrics (MH).

P 043

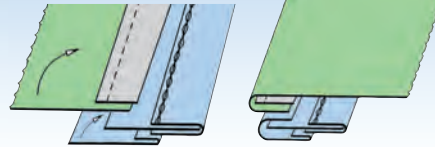

DÜZ MAKİNA KEMER ASTARI TAKMA APERESİ LOCKSTITCH MACHINE WAISTBAND LINING ATTACHMENT

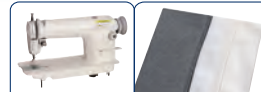

- Düz dikiş makinaları için üretilmiştir.
- Hazır kemer astarlarını kumaş pantolonlara takmak için kullanılır.
- Makine ayağı değiştirilir.
- Apara kemer astarlarının genişliğine göre ayarlanır.
- Produced for lockstitch sewing machines
- Used to attach the ready waistband linings to the fabric trousers.
- The machine foot can be changed.
- The attachment can be adjusted according to the width of the waistband lining.

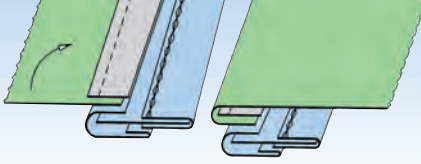

P 043A

DÜZ MAKİNA KIVIRMASIZ KEMER ASTARI TAKMA APERESİ LOCKSTITCH MACHINE WAISTBAND LINING ATTACHMENT

- Düz dikiş makinaları için üretilmiştir.
- Hazır kemer astarlarını kumaş pantolonlara takmak için kullanılır.
- Makine ayağı değiştirilir.
- Apara kemer astarlarının genişliğine göre ayarlanır.
- Produced for lockstitch sewing machines
- Used to attach the ready waistband linings to the fabric trousers.
- The machine foot can be changed.
- The attachment can be adjusted according to the width of the waistband lining.

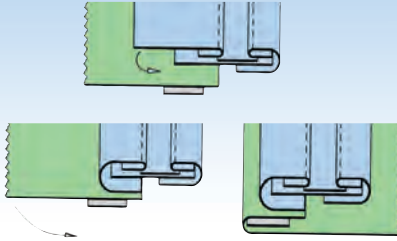

P 044

KEMER MAKİNASI KEMER ASTARI TAKMA APERESİ WAISTBAND MACHINE WAISTBAND LINING ATTACHMENT

- 4 iğne kemer makinaları ve 4 iğne lastik makinaları için üretilmiştir.
- Hazır kumaş astarını kumaş pantolonlara takmak için kullanılır.
- Apara kemer astarının genişliğine göre ayarlanır.
- Produced for 4 needles waistband machines and 4 needles rubber machines.
- Used to attach the ready waistband linings to the fabric trousers.
- The attachment can be adjusted according to the width of the waistband lining.

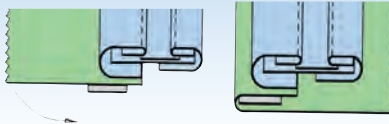

P 044A

KEMER MAKİNASI KIVIRMASIZ KEMER ASTARI TAKMA APERESİ WAISTBAND MACHINE WAISTBAND LINING ATTACHMENT

- 4 iğne kemer makinaları ve 4 iğne lastik makinaları için üretilmiştir.
- Hazır kumaş astarını kumaş pantolonlara takmak için kullanılır.
- Apara kemer astarının genişliğine göre ayarlanır.
- Produced for 4 needles waistband machines and 4 needles rubber machines.
- Used to attach the ready waistband linings to the fabric trousers.
- The attachment can be adjusted according to the width of the waistband lining.



P 044B

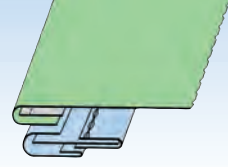
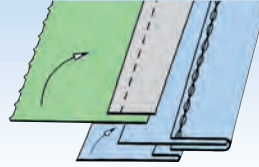

KEMER MAKİNASI ALTTAN KEMER ASTARI TAKMA APERESİ WAISTBAND MACHINE WAISTBAND LINING ATTACHMENT



- 4 iğne kemer makinaları ve 4 iğne lastik makinaları için üretilmiştir.
- Hazır kumaş astarını kumaş pantolonlara takmak için kullanılır.
- Apere kemer astarının genişliğine göre ayarlanır.
- Produced for 4 needles waistband machines and 4 needles rubber machines.
- Used to attach the ready waistband linings to the fabric trousers.
- The attachment can be adjusted according to the width of the waistband lining.

P 044C

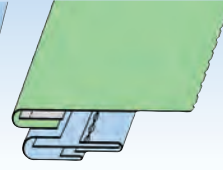
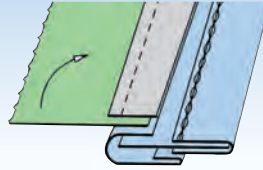

KEMER MAKİNASI ALTTAN KIVIRMASIZ KEMER ASTARI TAKMA APERESİ WAISTBAND MACHINE WAISTBAND LINING ATTACHMENT



- 4 iğne kemer makinaları ve 4 iğne lastik makinaları için üretilmiştir.
- Hazır kumaş astarını kumaş pantolonlara takmak için kullanılır.
- Apere kemer astarının genişliğine göre ayarlanır.
- Produced for 4 needles waistband machines and 4 needles rubber machines.
- Used to attach the ready waistband linings to the fabric trousers.
- The attachment can be adjusted according to the width of the waistband lining.

P 045

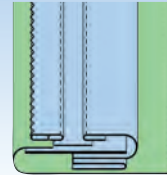
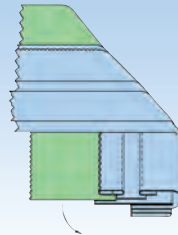
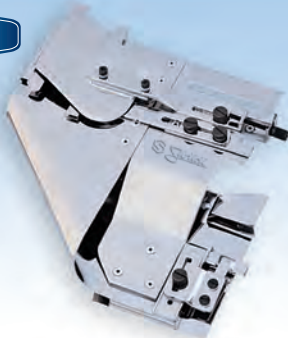

KEMER ASTARI TAKMA APERESİ WAISTBAND LINING ATTACHMENT.



- Union Special ve Rimoldi Kemer Astarı takma makinaları için üretilir.
- Hazır kemer astarını kumaş pantolonlarına takmak için kullanılır.
- Apere kemer astarının genişliğine göre ayarlanır.
- Produced for Union Special and Rimoldi waistband Lining machines.
- Used to attach the ready waistband linings to the fabric trousers.
- The attachment can be adjusted according to the width of the waistband lining.

Çıkış
Finish
Size
mm

10

12

15

20

25

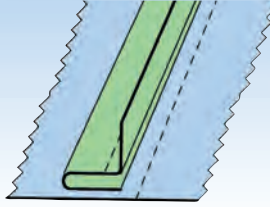

P 046



TEKLİ FLETO APERESİ SINGLE FLETO ATTACHMENT



- Fleto makinaları için üretilir.
- Kumaş pantolonların arka ceplerinde ve ceketlerin ön ceplerinde kullanılır.
- İnce kumaşlar (M) için üretilir.

- Produced for fleto machines.
- Used on the back pockets of the fabric trousers and on the front pockets of the jackets.
- Produced for light fabrics (M).

Çıkış
Finish
Size
mm

6

8

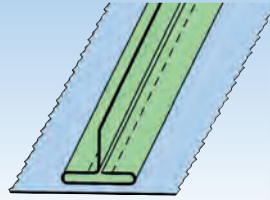

P 047



ÇİFTLİ FLETO APERESİ DOUBLE FLETO ATTACHMENT



- Fleto makinaları için üretilir.
- Kumaş pantolonlarının arka ceplerinde ve ceketlerin yan ceplerinde kullanılır.
- İnce kumaşlar (M) için üretilir.

- Used for fleto machines.
- Used on the back pockets of the fabric trousers and on the side pockets of the jackets.
- Produced for light fabrics (M).

Çıkış
Finish
Size
mm

6

8

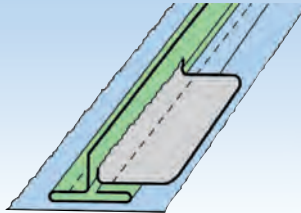

P 048



KAPAKLI FLETO APERESİ ATTACHMENT FOR FLETO WITH COVER



- Fleto makinaları için üretilir.
- Kumaş pantolonların arka ceplerinde ve ceketlerin yan ceplerinde kullanılır.

- Used for fleto machines.
- Used on the back pockets of the fabric trousers and on the side pockets of jackets.

P 049

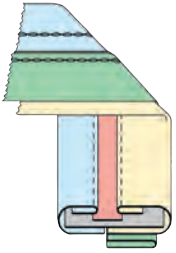
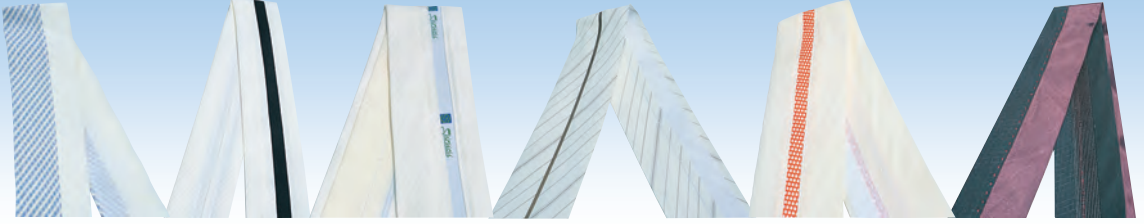
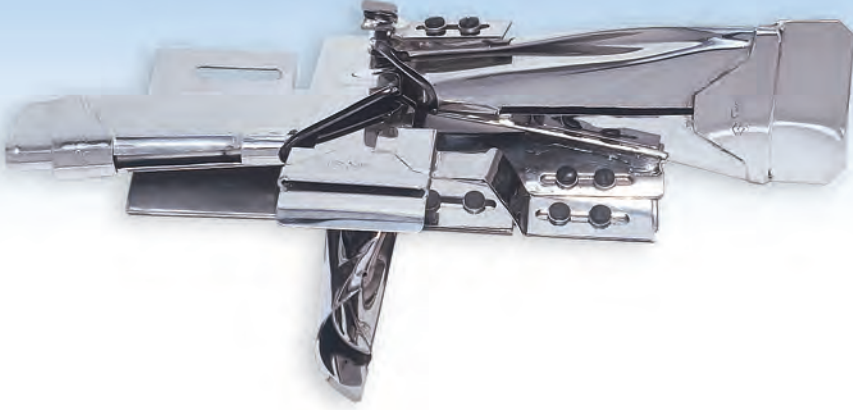

● P 049 A

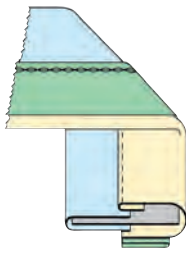

● P 049 B

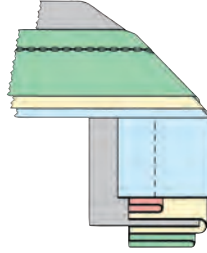

● P 049 C

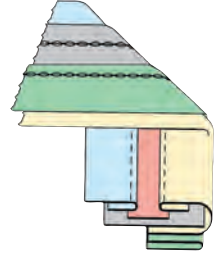

● P 049 F

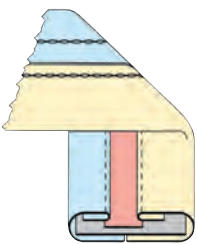

● P 049 D

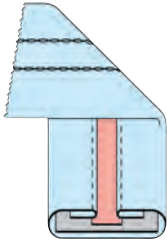

● P 049 E

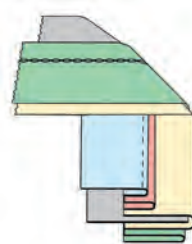

● P 049 G

KEMER ASTARI HAZIRLAMA APERESİ ATTACHMENT FOR PREPARATION OF THE WAISTBAND LINING



- 4 iğne kemer makinaları, 4 iğne lastik makinaları ve şerit makinaları için üretilmiştir.
- Kumaş pantolonların kemer kısımlarına monte edilir.
- Yapılacak aperlere numune model istenir.
- Ölçüler isteğe göre yapılır.
- Produced for 4 needles waistband machines, 4 needles rubber machines and ribbon machines.
- Mounted to the waistband parts of the fabric trousers.
- Sample of attachment is required to produce.
- The sizes are produced upon request.

P 050

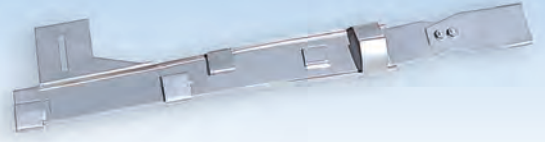
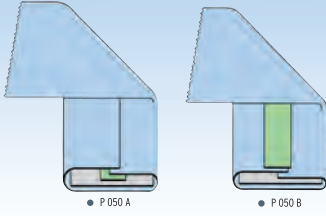

PRESS KEMER ASTARI HAZIRLAMA APERESİ

PRESS ATTACHMENT FOR PREPARATION OF THE WAISTBAND LINING

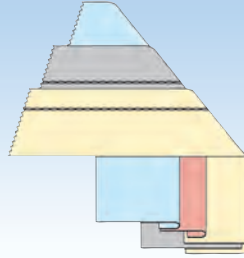

- Press ütü makinaları için üretilmiştir.
- Kumaş pantolonların kemer kısımlarında monte edilir.
- Yapılacak aparede numune model istenir.
- Ölçüler isteğe göre yapılır.
- Produced for press iron machines.
- Mounted to the waistband parts of the fabric trousers.
- Sample is required when it will be produced.
- The sizes are produced upon request.

Kemer Astarı
Belt liningAyarlı
Adjustable

P 050C

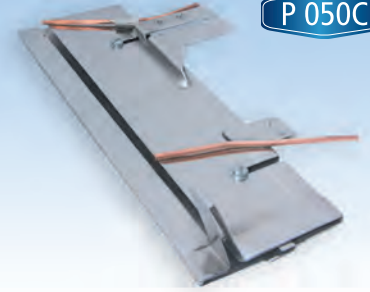

PRESTE GİZLİ DİKİŞ AÇMA APERESİ

HIDDEN STITCH FORMING ATTACHMENT WITH PRESS

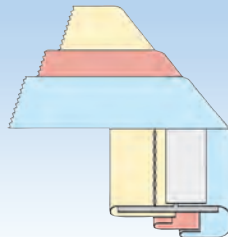

- Press ütü makinaları için üretilir.
- Pantolon kemer astarlarının gizli dikişini açmada kullanılır.
- Hava tertibatı gerekir
- Produced for press iron machines.
- Used for preparing hidden waistband linings of trousers.
- Used with pneumatic system.

Kemer Astarı
Belt liningAyarlı
Adjustable

P 050D



KAPALI KEMER ASTARI APERESİ

COVERED WAISTBAND LINING ATTACHMENT

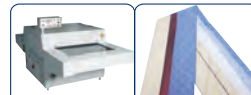

- Press ütü makinaları için üretilir
- Pantolonların kemer astarlarını tela ile kapatmada kullanılır
- Produced for press iron machines.
- Used for covering waistband linings of trousers with interfacing.

P 050E

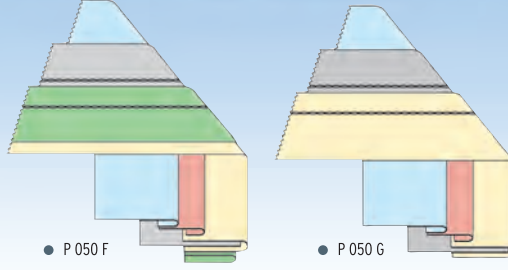

GİZLİ DİKİŞ AÇMA APERESİ HIDDEN STITCH FORMING ATTACHMENT



- Kemer makinası ve pres ütü makinaları için üretilmiştir.
- Pantolonların kemer astarının gizli dikişini açma ve dikmede kullanılır.
- Kemer makinasında körük dikilebilir.
- Produced for waistband machines and press iron machines.
- Used for forming and sewing hidden stitches of waistband linings.
- With waistband machines bellows can be sewed.

P 050H

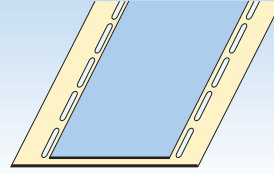

AYARLANABİLİR TAKVİYELİ TELA YAPIŞTIRMA APERESİ ADJUSTABLE SUPPORTED INTERFACING BONDING ATTACHMENT

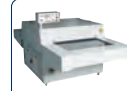

- Pres ütü makinaları için üretilir.
- Pantolon kemer astarlarının içine kullanılır.
- Çok amaçlı kullanım alanları vardır.
- Produced for press iron machines.
- Used for waistband linings of trousers.
- Multi purpose usage possible.

P 051A

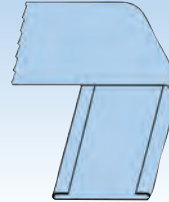

Giriş Cut Size mm	Çıkış Finish Size mm
200	170
210	180
220	190

ARKA CEP ASTARI KIVIRMA APERESİ BACK POCKET LINING FOLDING ATTACHMENT



- Pres ütü makinaları için üretilmiştir.
- Pantolonların arka cep astarı kenarlarını ütlemede kullanılır.
- Produced for press iron machines.
- Used for ironing edges of back pocket linings of trousers.

P 051

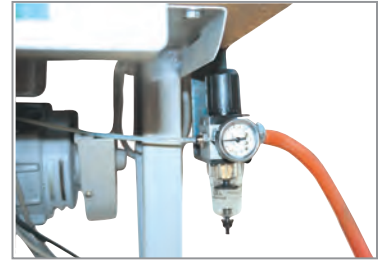
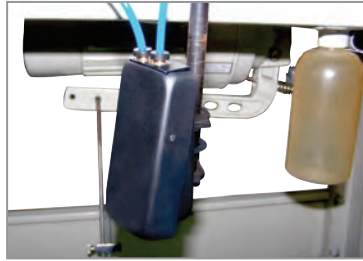
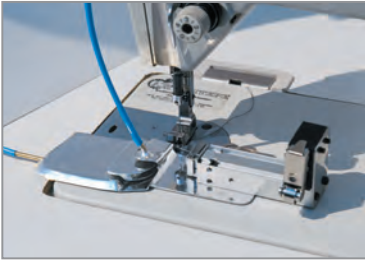
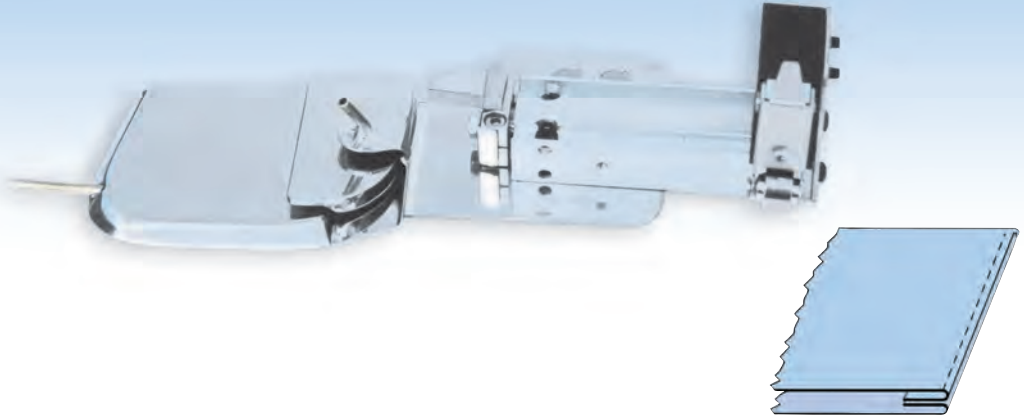

HAVALI CEP ASTARI APERESİ PNEUMATIC POCKET LINING ATTACHMENT



- Düz dikiş makinaları için üretilmiştir.
- Pantolonların cep astarı kısımlarında kullanılır.
- Hava tertibatı ile çalışır.

- Produced for lockstitch sewing machines.
- Used for pocket linings of trousers.
- Used with pneumatic system.

Giriş Cut Size mm	Çıkış Finish Size mm
12	6
14	7
15	7.5
16	8
18	9

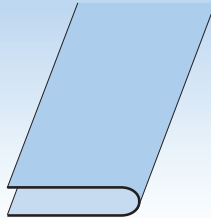

P 052A



CEKET ARABIYESİ ÜTÜLEME APERESİ JACKET/COAT ORNAMENT BINDING IRONING ATTACHMENT



- Pres ütü makinaları için üretilmiştir.
- Ceketlerin arabiyelerini ütülemede kullanılır.

- Produced for press iron machines.
- Used for ironing ornament bindings of jackets/coats.

P 052

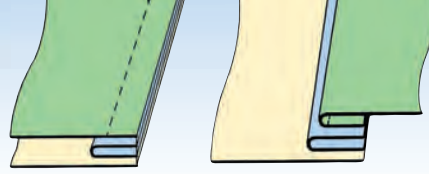

Arabiye Geniřliđi Ornament Binding Size mm
5
6
7
8
9
10

CEKET ARABİYE APERESİ ATTACHMENT FOR ORNAMENTS OF JACKETS

- Düz dikiř makinaları için üretilmiřtir.
- Ceketlerde kullanılır.



- Produced for lockstitch sewing machines.
- Used on jackets.

P 053

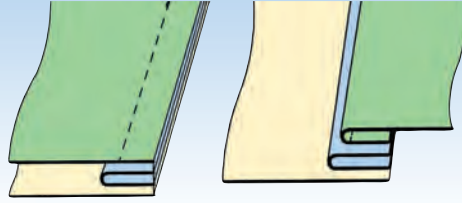

Giriř Cut Size mm	Çıkıř Finish Size mm
22	10
25	12
30	15

CEKET ARABİYE APERESİ ATTACHMENT FOR ORNAMENTS OF JACKETS

- Düz dikiř makinaları için üretilmiřtir.
- Ceketlerde kullanılır.



- Produced for lockstitch sewing machines.
- Used on jackets.

P 053A

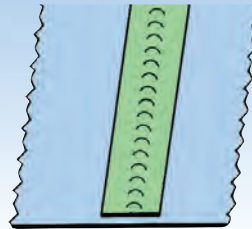

Çıkıř Finish Size mm
15
20

CEKET EKSTRAFOR APERESİ TAPE GUIDE FOR JACKETS

- Etek baskı makinaları için üretilmiřtir.
- Ceketlerin iç kısımlarında kullanılır.



- Produced for blindstitch belt-loop machines.
- Used for inner parts of the jackets.

P 054

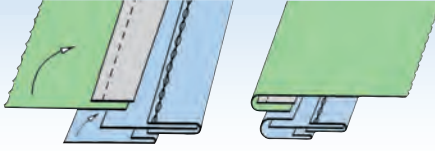

ÇİFT İĞNE MAKİNASI KEMER ASTARI TAKMA APERESİ DOUBLE NEEDLE WAISTBAND LINING ATTACHMENT

- Çift iğne dikiş makinaları için üretilmiştir.
- Hazır kemer astarlarını kumaş pantolonlara takmak için kullanılır.
- Apara kemer astarlarının genişliğine göre ayarlanır.
- Produced for double needle sewing machines
- Used to attach the ready waistband linings to the fabric trousers.
- The attachment can be adjusted according to the width of the waistband lining.



P 055

Cıkaş Finish Size mm
12
12.5
13
13.5
14
14.5
15
15.5
16
16.5
17

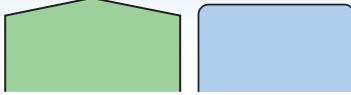

CEKET KAPAĞI APERESİ JACKET/COAT COVER ATTACHMENT

- Bıçaklı düz dikiş makinaları için üretilmiştir.
- Ceketlerin cep kapaklarını üretmede kullanılır.
- Produced for lockstitch sewing machines with knife.
- Used for forming pocket cover parts of jackets/coats.



P 056

Cıkaş Finish Size mm
12
12.5
13
13.5
14
14.5
15
15.5
16
16.5
17

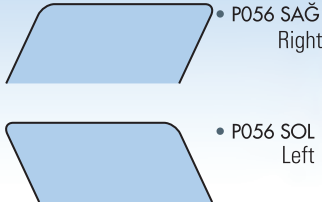

SAĞA SOLA EĞİK CEKET KAPAĞI APERESİ RIGHT OR LEFT BENT JACKET/COAT COVER ATTACHMENT

- Bıçaklı düz dikiş makinaları için üretilmiştir.
- Ceketlerin cep kapaklarını üretmede kullanılır.
- Produced for lockstitch sewing machines with knife.
- Used for forming pocket cover parts of jackets/coats.

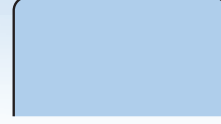

P 056A

Çıkış
Finish
Size
mm

12
12.5
13
13.5
14
14.5
15
15.5
16
16.5
17

OTOMAT CEKET KAPAĞI APERESİ AUTOMATIC JACKET / COAT COVER ATTACHMENT



- Otomat düz makinalar için üretilmiştir.
- Ceket cep kapakları üretiminde kullanılır.

- Produced for automatic lockstitch sewing machines.
- Used for covers of jacket/coat pockets.

P 057

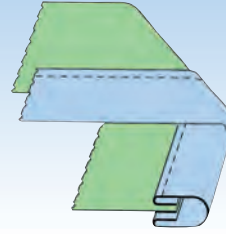
Giriş
Cut
Size
mmÇıkış
Finish
Size
mm

30	8
35	10
40	12
45	14
50	15

DÜZ MAKİNA BİYE APERESİ LOCKSTITCH POCKET ATTACHMENT



- Düz dikiş makinaları için üretilmiştir.
- Pantolon kemerlerinin iç kısımlarına biye çekmede kullanılır.

- Produced for lockstitch sewing machines.
- Used for forming bindings of inner parts of trouser belts.

P 057A

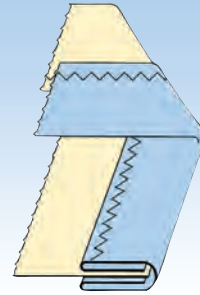
Giriş
Cut
Size
mmÇıkış
Finish
Size
mm

25	6
28	7
30	8
35	10
40	12

ZİGZAG MAKİNASI CEKET ASTARI BİYE APERESİ ZIGZAG SEWING MACHINE ATTACHMENT



- Zıgzag dikiş makinaları için üretilmiştir.
- Ceketlerin mostralarna biye çekmek için kullanılır.
- Dişli plaka ve ayak değiştirilir.

- Produced for zig-zag sewing machines.
- Used for tape binding of jacket lapels.
- Needle plate, feed dog and foot set is changed.

Giriş Cut Size mm	Çıkış Finish Size mm
20	10
25	12
30	15

P 058

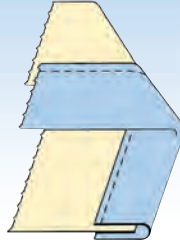

DÜZ MAKİNA İKİYE KATLAMA APERESİ LOCKSTITCH MACHINE ATTACHMENT FOR FOLDING INTO TWO



- Düz dikiş makinaları için üretilmiştir.
- Pantolonlarda, ceketlerde ve montlarda çeşitli amaçlarla kullanılır.
- Produced for lockstitch sewing machines.
- Multi-purpose usage for jackets, coats and trousers.

P 059

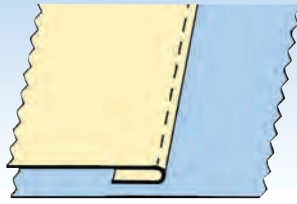

DÜZ MAKİNA CEP KARŞILIĞI APERESİ LOCKSTITCH MACHINE INNER LINING ATTACHMENT FOR POCKETS



- Düz dikiş makinaları için üretilmiştir.
- Kumaş pantolonların ceph karşılığında kullanılır.
- Produced for lockstitch sewing machines.
- Used for inner parts of pockets.

Giriş Cut Size mm	Çıkış Finish Size mm
20	4
25	5
30	6
35	7
40	10

P 060

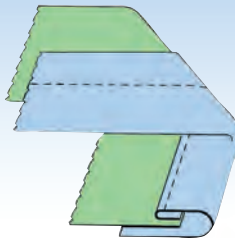

ALTI AÇIK DÜZ MAKİNA APERESİ OPEN BÖTTÖM LOCKSTITCH MACHINE ATTACHMENT

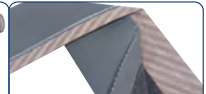

- Düz dikiş makinaları için üretilmiştir.
- Pantolon kemerlerinin iç kısımlarına biye çekmede kullanılır.
- Produced for lockstitch sewing machines.
- Used for making bindings on inner parts of trousers belts.

E101

Lastik Genişliği
Rubber Size
mm

20

25

30

35

40

50

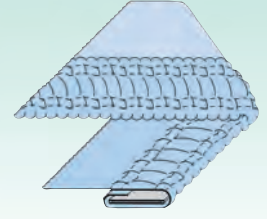
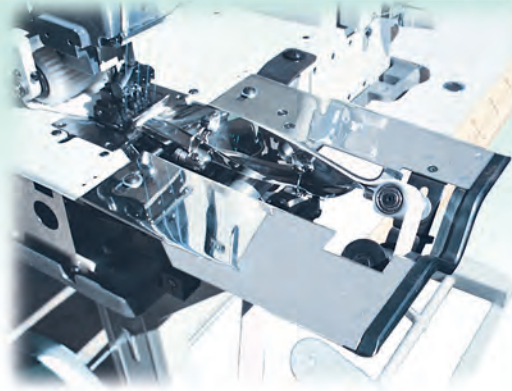

● E101 A

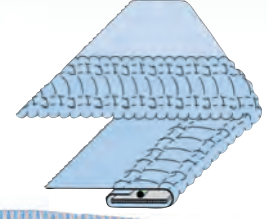

● E101 B

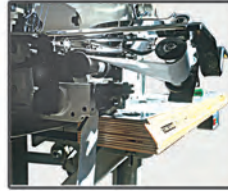

EŞOFMAN BEL LASTİK APRESİ WAIST RUBBER ATTACHMENT FOR JOGGING SUITS



- 4 iğne Lastik makinaları için üretilmiştir.
- Makinanın ÖN ve ARKA KISIMLARINDA MERDANE OLMASI gerekmektedir.
- Eşofmanların, şortların ve bayan eteklerinin bel kısımlarında kullanılır.
- Kanal üstündeki yay sistemi her kumaşın aparede kolaylıkla çalışmasını sağlamaktadır.
- Produced for the 4 needles rubber machines.
- There must be CYLINDER IN FRONT and BACK PARTS of the machine.
- Used in the waist parts of jogging suits, shorts and the lady skirts.
- The spring system on the channel provides every fabric to work easily in the attachment.

E101C

Lastik Genişliği
Rubber Size
mm

Ayarlı

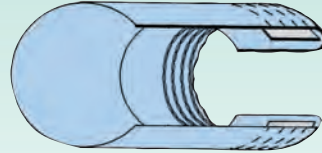

E101D

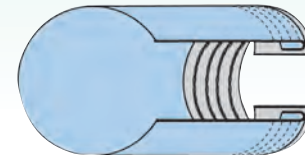
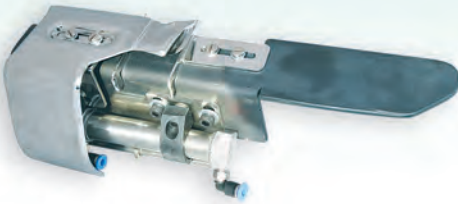

TÜP BEL LASTİK APRESİ TUBE WAIST RUBBER ATTACHMENT

- Burunlu lastik makinaları için üretilir.
- Şortlara bel lastiği takmada kullanılır.
- Lastik ölçüsü ayarlanabilir.
- Hava tertibatı gereklidir.
- Produced for cylinder rubber machines.
- Used for putting waist rubbers on shorts.
- Adjustable rubber size.
- Requires air system.

Giriş Cut Size mm	Çıkış Finish Size mm
100	50
110	55
120	60
130	65

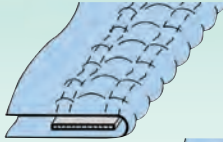

● E 102 A

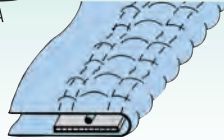

● E 102 B



E102

Lastik Geniřliđi Rubber Size mm
30
35
40
50

LASTIKLİ KEMER APERESİ BELT ATTACHMENT WITH RUBBER

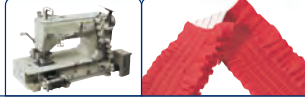

- 4 iđne Lastik makinaları için üretilmiřtir.
- Makinanın ÖN ve ARKA KISIMLARINDA MERDANE OLMASI gerekmektedir.
- Eřofman ve řortların bel kısımlarında kullanılır.
- İnce kumařlar (M) için üretilmiřtir.
- Produced for 4 needles rubber machines.
- There must be CYLINDER IN FRONT and BACK PARTS of the machine.
- Used on the waist parts of jogging suits and shorts.
- Produced for light fabrics (M).

Giriş Cut Size mm	Çıkış Finish Size mm	Lastik Geniřliđi Rubber Size mm
50	30	30
55	30	35
60	35	40
60	38	
65	40	
70	42	

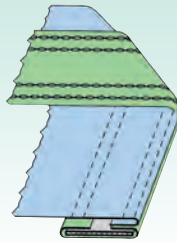

E103

LASTIKLİ KİTİL APERESİ KITIL ATTACHMENT WITH RUBBER



- 4 iđne Lastik makinaları için üretilmiřtir.
- Eřofmanların, řortların ve kumař pantolonların bel kısımlarında kullanılır.
- İnce kumařlar (M) ve Orta Kumařlar (MH) için üretilir.
- Produced for the 4 needles rubber machines.
- Used on the waist parts of jogging suits, shorts and fabric trousers.
- Produced for light fabrics (M) and medium fabrics (MH).

Giriş Cut Size mm	Çıkış Finish Size mm	Giriş Cut Size mm	Çıkış Finish Size mm
18	8	50	30
22	10	55	32
24	12	60	35
28	14	60	38
32	16	65	40
35	18	65	42
40	20	70	40
40	22	70	42
45	25	75	45
45	27		

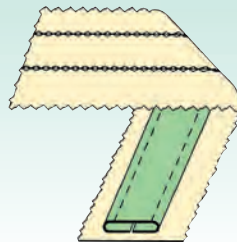

E104

ŞERİT MAKİNASI ŞERİT APERESİ RIBBON MACHINE RIBBON ATTACHMENT



- Tüm řerit makinaları için üretilir.
- Eřofmanlarda, řortlarda ve tiřörlerde çeřitli amaçlarla kullanılır.
- Çok ince kumařlar (L) ve ince kumařlar (M) için üretilir.
- Produced for all ribbon machines.
- Used on jogging suits, shorts and t-shirts for different purposes.
- Produced for very light fabrics (L) and light fabrics (M).

E104A

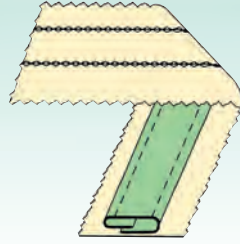

Giriş Cut Size mm	Çıkış Finish Size mm
15	6
20	8
25	10
28	12
30	13
36	16
45	20
48	22

ŞERİT MAKİNASI BINDİRMELİ ŞERİT APERESİ OVERLAPPING RIBBON ATTACHMENT

- Tüm şerit makineleri için üretilir.
- Eşofmanlarda, şortlarda ve tişörtlerde çeşitli amaçlarla kullanılır.
- Açık renkli kumaşları tam katlayarak koyu bedenler üzerinde hoş görünmesini sağlar.
- Çok ince kumaşlar (L) ve ince kumaşlar (M) için üretilir.



- Produced for all ribbon machines.
- Used on jogging suits, shorts and t-shirts for different purposes.
- Ensures nice looking of light colored fabrics on dark bodies by complete folding
- Produced for very light fabrics (L) and light fabrics (M).

E104B

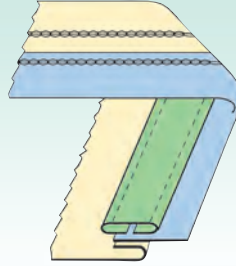

Giriş Cut Size mm	Çıkış Finish Size mm
18	8
22	10

ZİNCİR DİKİŞ ŞERİT APERESİ CHAIN STITCH RIBBON ATTACHMENT

- Zincir dikiş makineleri için üretilir.
- Tişörtlerin, yaka ve omuz içlerinde kullanılır
- Apele makinenin ayağına monte edilir.



- Produced for chain stitch machines.
- Used for inner shoulder parts of collars of t-shirts.
- Attachment mounted to machine foot.

E104C

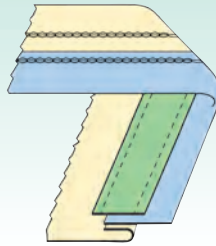

Çıkış Finish Size mm
10
14

ZİNCİR DİKİŞ EKSTRAFOR APERESİ CHAINSTITCH TAPE GUIDE ATTACHMENT

- Zincir dikiş makineleri için üretilmiştir.
- Tişörtlerin yaka ve omuz içlerinde kullanılır.
- Apele makinaların ayağına monte edilir.



- Produced for chainstitch sewing machines.
- Used for collar and inner shoulder parts of t-shirts.
- Attachment is mounted to foot of the sewing machine.

Giriş Cut Size mm	Çıkış Finish Size mm	İğne Aralığı Needle Size mm
15	6	3.2
18	8	4.8-5.6
22	10	6.4

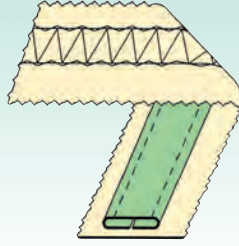

E105

REÇME MAKİNASI ŞERİT APERESİ RIBBON ATTACHMENT FOR INTERLOCK MACHINES

- Reçme makinaları için üretilmiştir.
- Eşofmanlarda, şortlarda ve tişörtlerde çeşitli amaçlarda kullanılır.
- Çok ince kumaşlar (L) ve ince kumaşlar (M) için üretilmiştir.

- Produced for interlock machines.
- Used on jogging suits, shorts and t-shirts for different purposes.
- Produced for very light fabrics (L) and light fabrics (M).



Giriş Cut Size mm	Çıkış Finish Size mm
15	6
20	8
25	10

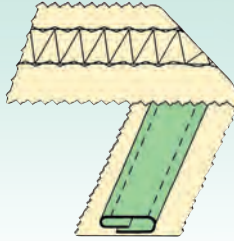

E105A

REÇME MAKİNASI BİNDİRMELİ ŞERİT APERESİ OVERLAPPING RIBBON ATTACHMENT FOR INTERLOCK MACHINES

- Reçme makinaları için üretilmiştir.
- Eşofmanlarda, şortlarda ve tişörtlerde çeşitli amaçlarda kullanılır.
- Ağık renkli kumaşları tam katlayarak koyu bedenler üzerinde hoş görünümünü sağlar.
- Çok ince kumaşlar (L) ve ince kumaşlar (M) için üretilmiştir.

- Produced for interlock machines.
- Used on jogging suits, shorts and t-shirts for different purposes.
- Ensures nice looking of light colored fabrics on dark bodies by complete folding
- Produced for very light fabrics (L) and light fabrics (M).



Giriş Cut Size mm	Çıkış Finish Size mm
25	6
28	7
30	8
35	10
40	12

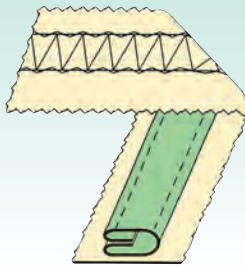

E105B

REÇME ÜSTTEN DÖRDE KATLAMA ŞERİT APERESİ INTERLOCK MACHINE FOLDING INTO FOUR FROM TOP ATTACHMENT

- Reçme makinaları için üretilmiştir.
- Eşofmanlarda, şortlarda ve tişörtlerde çeşitli amaçlarda kullanılır.
- Çok ince kumaşlar (L) ve ince kumaşlar (M) için üretilmiştir.

- Produced for interlock sewing machines.
- Used for various parts of training wears, shorts and t-shirts.
- Produced for very light fabrics (L) and light fabrics (M).



E106

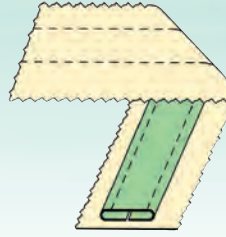

İğne Aralığı Needle Size mm	Giriş Cut Size mm	Çıkış Finish Size mm	Giriş Cut Size mm	Çıkış Finish Size mm
3.2	15	6	40	22
4.8-5.6	18	8	45	25
6.4	22	10	45	27
	24	12	50	28
	28	14	50	30
	32	16	55	32
	35	18	60	35
	40	20		

ÇİFT İĞNE ŞERİT APERESİ RIBBON ATTACHMENT FOR DOUBLE NEEDLE MACHINES

- Çift iğne dikiş makinaları için üretilmiştir.
- Eşofmanlarda, şortlarda ve tişörtlerde çeşitli amaçlarla kullanılır.
- Çok ince kumaşlar (L) ve ince kumaşlar (M) için üretilmiştir.



- Produced for double needle machines.
- Used on jogging suits, shorts and t-shirts for different purposes.
- Produced for very light fabrics (L) and light fabrics (M).

E106A

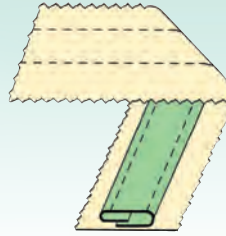

Giriş Cut Size mm	Çıkış Finish Size mm
15	6
20	8
25	10
28	12
30	13
36	16
45	20
48	22

ÇİFT İĞNE BİNDİRMELİ ŞERİT APERESİ DOUBLE NEEDLE OVERLAPPING RIBBON ATTACHMENT

- Çift iğne dikiş makinaları için üretilmiştir.
- Eşofmanlarda, şortlarda ve tişörtlerde çeşitli amaçlarla kullanılır.
- Açık renkli kumaşları tam katlayarak koyu bedenler üzerinde hoş görünümünü sağlar.
- Çok ince kumaşlar (L) ve ince kumaşlar (M) için üretilmiştir.



- Produced for double needle machines.
- Used on jogging suits, shorts and t-shirts for different purposes.
- Ensures nice looking of light colorod fabrics on dark bodies by complete folding.
- Produced for very light fabrics and light fabrics.

E106B

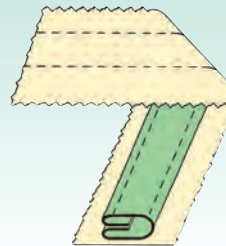

Giriş Cut Size mm	Çıkış Finish Size mm
25	6
28	7
30	8
35	10
40	12

ÇİFT İĞNE DÖRDE KATLAMA ŞERİT APERESİ DOUBLE NEEDLE MACHINE FOLDING INTO FOUR RIBBON ATTACHMENT

- Çiftiğne makinaları için üretilmiştir.
- Eşofmanlarda, şortlarda ve tişörtlerde çeşitli amaçlarda kullanılır.
- Çok ince kumaşlar (L) ve ince kumaşlar (M) için üretilmiştir.



- Produced for double needle sewing machines.
- Used for various parts of training wears, shorts and t-shirts.
- Produced for very light fabrics (L) and light fabrics (M).

Şerit Ribbon		Arabiye Ornament Binding		Şerit Ribbon		Arabiye Ornament Binding	
Giriş Cut Size mm	Çıkış Finish Size mm	Giriş Cut Size mm	Çıkış Finish Size mm	Giriş Cut Size mm	Çıkış Finish Size mm	Giriş Cut Size mm	Çıkış Finish Size mm
22	10	22	10	60	35	25	12
24	12			60	38		
28	14			65	40		
32	16			65	42		
35	18			70	40		
40	20			70	42		
40	22			75	45		
45	25						
45	27						
50	28						
50	30						
55	32						

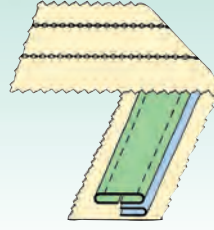

E107

ŞERİT MAKİNASI SÜSBİYELİ ŞERİT APERESİ RIBBON ATTACHMENT OF ORNAMENT BINDING FOR RIBBON MACHINES

- Tüm şerit makinaları için üretilir.
- Eşofmanlarda, şortlarda ve tişörtlerde çeşitli amaçlarla kullanılır.
- Çok ince kumaşlar (L) ve ince kumaşlar (M) için üretilir.

- Produced for all ribbon machines.
- Used on jogging suits, shorts and t-shirts for different purposes.
- Produced for very light fabrics (L) and light fabrics (M).



Şerit Ribbon		Yan Biye Binding	
Giriş Cut Size mm	Çıkış Finish Size mm	Giriş Cut Size mm	Çıkış Finish Size mm
22	10	22	10
24	12		
28	14		
32	16		
35	18		
40	20	28	13
40	22		

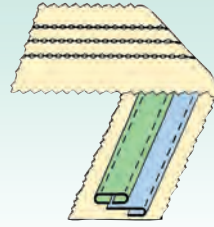

E107A

ŞERİT MAKİNASI YAN BİYELİ ŞERİT APERESİ RIBBON MACHINE SIDE BINDING RIBBON ATTACHMENT

- Tüm şerit makinaları için üretilir.
- Eşofmanlarda, şortlarda ve tişörtlerde çeşitli amaçlarla kullanılır.
- Çok ince kumaşlar (L) ve ince kumaşlar (M) için üretilir.

- Produced for all ribbon machines.
- Used on jogging suits, shorts and t-shirts for different purposes.
- Produced for very light fabrics (L) and light fabrics (M).



Şerit Ribbon		Arabiye Ornament Binding	
Giriş Cut Size mm	Çıkış Finish Size mm	Giriş Cut Size mm	Çıkış Finish Size mm
22	10	22	10

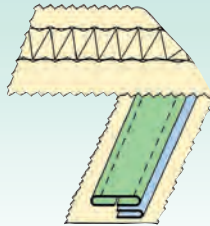

E108

REÇME MAKİNASI SÜS BİYELİ ŞERİT APERESİ RIBBON ATTACHMENT OF ORNAMENT BINDING FOR INTERLOCK MACHINES

- Reçme makinaları için üretilmiştir.
- Eşofmanlarda, şortlarda ve tişörtlerde çeşitli amaçlarla kullanılır.
- Çok ince kumaşlar (L) ve ince kumaşlar (M) için üretilir.

- Produced for interlock machines.
- Used on jogging suits, shorts and t-shirts for different purposes.
- Produced for very light fabrics (L) and light fabrics (M).



E109

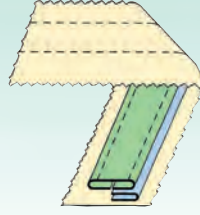

Şerit Ribbon		Arabiye Ornament Binding		Şerit Ribbon		Arabiye Ornament Binding	
Giriş Cut Size mm	Çıkış Finish Size mm	Giriş Cut Size mm	Çıkış Finish Size mm	Giriş Cut Size mm	Çıkış Finish Size mm	Giriş Cut Size mm	Çıkış Finish Size mm
22	10	22	10	45	27	22	10
24	12			50	28		
28	14			50	30		
32	16			55	32	25	12
35	18			60	35		
40	20						
40	22						
45	25						

ÇİFT İĞNE MAKİNASI SÜS BİYELİ ŞERİT APERESİ RIBBON ATTACHMENT OF ORNAMENT BINDING FOR DOUBLE STITCH MACHINES



- Çift iğne dikiş makinaları için üretilmiştir.
- Eşofmanlarda, şortlarda ve tişörtlerde çeşitli amaçlarla kullanılır.
- Çok ince kumaşlar (L) ve ince kumaşlar (M) için üretilmiştir.

- Produced for double stitch machines.
- Used on jogging suits, shorts and t-shirts for different purposes.
- Produced for very light fabrics (L) and light fabrics (M).

E110

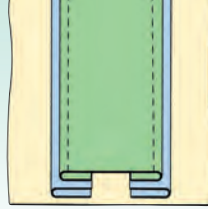

Şerit Ribbon		Arabiye Ornament Binding		Şerit Ribbon		Arabiye Ornament Binding	
Giriş Cut Size mm	Çıkış Finish Size mm	Giriş Cut Size mm	Çıkış Finish Size mm	Giriş Cut Size mm	Çıkış Finish Size mm	Giriş Cut Size mm	Çıkış Finish Size mm
40	22	22	10	60	35	25	12
45	25			60	38		
45	27			65	40		
50	28			65	42		
55	32			70	40		
		70	42				
				75	45		

ŞERİT MAKİNASI ÇİFT SÜSBİYELİ ŞERİT RIBBON ATTACHMENT OF DOUBLE ORNAMENT BINDING FOR RIBBON MACHINES



- Tüm şerit makinaları için üretilmiştir.
- Eşofmanlarda ve tişörtlerde çeşitli amaçlarla kullanılır.
- Çok ince kumaşlar (L) ve ince kumaşlar (M) için üretilir.

- Produced for all ribbon machines.
- Used on jogging suits and t-shirts for different purposes.
- Produced for very light fabrics (L) and light fabrics (M).

E111

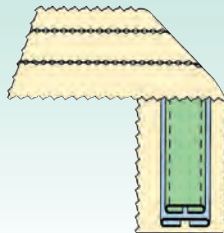

Küçük Apeře Small Ribbon Atta.		Büyük Apeře Big Ribbon Atta.	
Giriş Cut Size mm	Çıkış Finish Size mm	Giriş Cut Size mm	Çıkış Finish Size mm
18	8	24	12
22	10	28	14
24	12	32	15

ŞERİT MAKİNASI ÇİFT SÜSBİYELİ ŞERİT APERESİ RIBBON ATTACHMENT OF DOUBLE ORNAMENT BINDING FOR RIBBON MACHINES



- Tüm şerit makinaları için üretilmiştir.
- Eşofmanlarda ve tişörtlerde çeşitli amaçlarla kullanılır.
- Çok ince kumaşlar (L) ve ince kumaşlar (M) için üretilir.

- Produced for all ribbon machines.
- Used on jogging suits, and t-shirts for different purposes.
- Produced for very light fabrics (L) and light fabrics (M).

Küçük Apere Small Ribbon Atta.		Büyük Apere Big Ribbon Atta.	
Giriş Cut Size mm	Çıkış Finish Size mm	Giriş Cut Size mm	Çıkış Finish Size mm
15	6	22	10
18	8	24	12
22	10	28	14

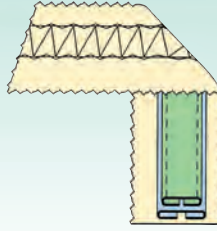

E112

REÇME MAKİNASI ÇİFT SÜSBİYELİ ŞERİT APERESİ RIBBON ATTACHMENT OF DOUBLE ORNAMENT BINDING FOR INTERLOCK MACHINES

- Reçme makinaları için üretilmiştir.
- Eşofmanlarda ve tişörtlerde çeşitli amaçlarla kullanılır.
- Çok ince kumaşlar (L) ve ince kumaşlar (M) için üretilmiştir.

Küçük Apere Small Ribbon Atta.		Büyük Apere Big Ribbon Atta.		Şerit/Ribbon		Arabiyeye Ornament Binding	
Giriş Cut Size mm	Çıkış Finish Size mm	Giriş Cut Size mm	Çıkış Finish Size mm	Giriş Cut Size mm	Çıkış Finish Size mm	Giriş Cut Size mm	Çıkış Finish Size mm
15	6	22	10	40	22	22	10
18	8	24	12	45	25		
22	10	28	14	45	27		
24	12	32	15	50	28		
				55	32		
				60	35		

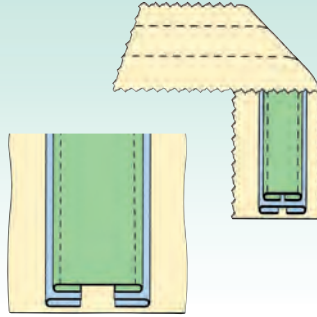

E113

- Produced for interlock machines.
- Used on jogging suits, and t-shirts for different purposes.
- Produced for very light fabrics (L) and light fabrics (M).

ÇİFT İĞNE ÇİFT SÜSBİYELİ ŞERİT APERESİ RIBBON ATTACHMENT OF DOUBLE ORNAMENT BINDING FOR DOUBLE NEEDLE MACHINES

- Çift iğne dikiş makinaları için üretilmiştir.
- Eşofmanlarda ve tişörtlerde çeşitli amaçlarla kullanılır.
- Çok ince kumaşlar (L) ve ince kumaşlar (M) için üretilmiştir.

Giriş Cut Size mm	Çıkış Finish Size mm
22	10
24	12
28	14

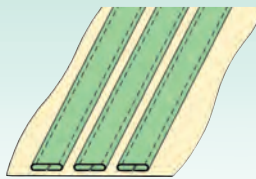

E114

- Produced for double needle machines.
- Used on jogging suits, and t-shirts for different purposes.
- Produced for very light fabrics (L) and light fabrics (M).

ÜÇLÜ ŞERİT APERESİ ATTACHMENT FOR THREE RIBBONS

- Tüm şerit makinaları için üretilmiştir.
- Eşofmanlarda ve tişörtlerde kullanılır.
- Çok ince kumaşlar (L) ve ince kumaşlar (M) için üretilmiştir.

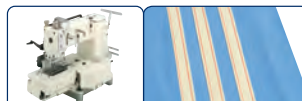

- Produced for all ribbon machines.
- Used on jogging suits and t-shirts.
- Produced for very light fabrics (L) and light fabrics (M).

E114A

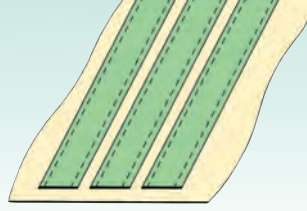
Çıkış
Finish
Size
mm8
10
12
14
16

ÜÇLÜ EKSTRAFOR APERESİ TRIPLE TAPE GUIDE ATTACHMENT

- Tüm şerit makinaları için üretilmiştir.
- Eşofmanlarda ve tişörtlerde kullanılır.
- Çok ince kumaşlar (L) ve ince kumaşlar (M) için üretilmiştir.



- Produced for all ribbon machines.
- Used for training wears and t-shirts.
- Produced for very light fabrics (L) and light fabrics (M).

E115

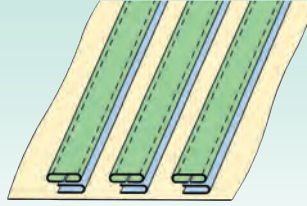

Şerit Ribbon		Arabiye Ornament Binding	
Giriş Cut Size mm	Çıkış Finish Size mm	Giriş Cut Size mm	Çıkış Finish Size mm
22	10		
24	12	22	10
28	14		

SÜS BİYELİ ÜÇLÜ ŞERİT APERESİ ATTACHMENT FOR THREE RIBBONS WITH ORNAMENT BINDING

- İğne aralığı uygun şerit makinaları için üretilir.
- Eşofmanlarda ve tişörtlerde kullanılır.
- Çok ince kumaşlar (L) ve ince kumaşlar (M) için üretilmiştir.



- Produced for machines with suitable needle interval.
- Used on jogging suits and t-shirts.
- Produced for very light fabrics (L) and light fabrics (M).

E116

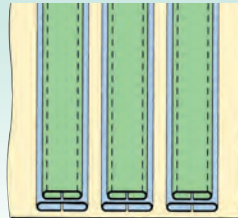

Küçük Ape Small Ribbon Atta.		Büyük Ape Big Ribbon Atta.	
Giriş Cut Size mm	Çıkış Finish Size mm	Giriş Cut Size mm	Çıkış Finish Size mm
18	8	24	12
22	10	28	14
24	12	32	15

ÇİFT SÜS BİYELİ ÜÇLÜ ŞERİT APERESİ ATTACHMENT FOR THREE RIBBONS WITH DOUBLE ORNAMENT BINDING

- İğne aralığı uygun şerit makinaları için üretilir.
- Eşofmanlarda ve tişörtlerde kullanılır.
- Çok ince kumaşlar (L) ve ince kumaşlar (M) için üretilmiştir.



- Produced for machines with suitable needle interval.
- Used on jogging suits and t-shirts.
- Produced for very light fabrics (L) and light fabrics (M).

Küçük Apere Small Ribbon Atta.		Büyük Apere Big Ribbon Atta.		Arabiye Ornament Binding	
Giriş Cut Size mm	Çıkış Finish Size mm	Giriş Cut Size mm	Çıkış Finish Size mm	Giriş Cut Size mm	Çıkış Finish Size mm
18	8	35	18	20	9
22	10	40	22	22	10
24	12	55	32	22	10

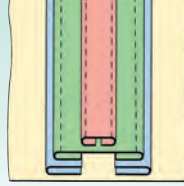

E117

ÇİFT ŞERİT ÇİFT SÜSBİYELİ ŞERİT APERESİ ATTACHMENT FOR DOUBLE RIBBONS WITH DOUBLE ORNAMENT BINDING



- İğne aralığı uygun şerit makinaları için üretilir.
- Eşofmanlarda ve tişörtlerde kullanılır.
- Çok ince kumaşlar (L) ve ince kumaşlar (M) için üretilmiştir.
- Produced for machines with suitable needle interval.
- Used on jogging suits and t-shirts.
- Produced for very light fabrics (L) and light fabrics (M).

Şerit Aperesi Ribbon Attachment		Düz Şerit Flat Ribbon Atta.		Arabiye Ornament Binding	
Giriş Cut Size mm	Çıkış Finish Size mm	Giriş Cut Size mm	Çıkış Finish Size mm	Giriş Cut Size mm	Çıkış Finish Size mm
22	10	16		22	10
24	12	22		22	10

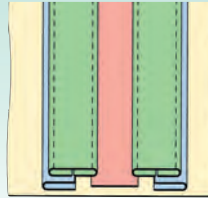

E118

ŞERİT APERESİ RIBBON ATTACHMENT

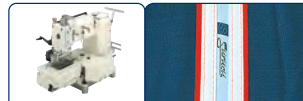

- İğne aralığı uygun şerit makinaları için üretilir.
- Eşofmanlarda ve tişörtlerde kullanılır.
- Çok ince kumaşlar (L) ve ince kumaşlar (M) için üretilmiştir.
- Produced for machines with suitable needle interval.
- Used on jogging suits and t-shirts.
- Produced for very light fabrics (L) and light fabrics (M).

Küçük Şerit Small Ribbon		Orta Şerit Medium Ribbon		Büyük Şerit Big Ribbon	
Giriş Cut Size mm	Çıkış Finish Size mm	Giriş Cut Size mm	Çıkış Finish Size mm	Giriş Cut Size mm	Çıkış Finish Size mm
18	8	35	18	50	28
22	10	40	22	60	35

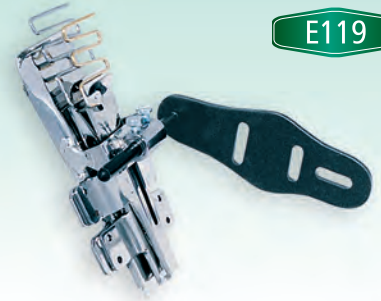
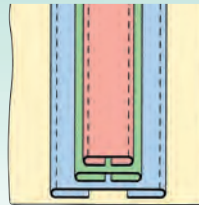

E119

ÜÇ ŞERİT ÜST ÜSTE APERE ATTACHMENT FOR THREE RIBBONS BINDED (UP TO UP)



- İğne aralığı uygun şerit makinaları için üretilir.
- Eşofmanlarda ve tişörtlerde kullanılır.
- Çok ince kumaşlar (L) ve ince kumaşlar (M) için üretilmiştir.
- Produced for machines with suitable needle interval.
- Used on jogging suits and t-shirts.
- Produced for very light fabrics (L) and light fabrics (M).

E119A

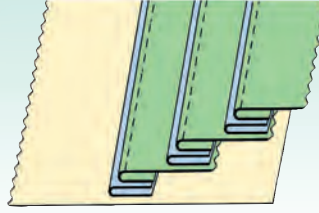

SÜSBİYELİ ŞERİT APERESİ ATTACHMENT FOR RIBBONS WITH ORNAMENT BINDING

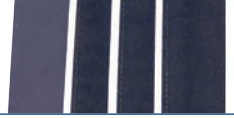

- İğne aralığı uygun şerit makinaları için üretilir.
- Eşofmanlarda ve tişörtlerde kullanılır.
- Çok ince kumaşlar (L) ve ince kumaşlar (M) için üretilmiştir.

- Produced for machines with suitable needle interval.
- Used on jogging suits and t-shirts.
- Produced for very light fabrics (L) and light fabrics (M).

E 120

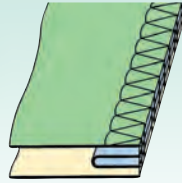

Giriş Cut Size mm	Çıkış Finish Size mm
20	10
25	12
30	15
35	17
40	20
45	22
50	25

OVERLOK MAKİNASI ARABIYE APERESİ ORNAMENT BINDING ATTACHMENT FOR OVERLOCK MACHINES

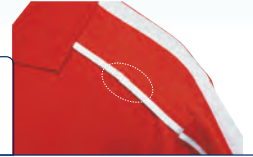

- Overlok makinaları için üretilir.
- Eşofmanlarda, şortlarda, tişörtlerde, pantolonlarda ve montlarda kullanılır.
- İnce kumaşlar (M) ve orta kumaşlar (MH) için üretilir.

- Produced for overlock machines.
- Used on jogging suits, t-shirts, trousers and jackets.
- Produced for light fabrics (M) and medium fabrics (MH).

E 120A

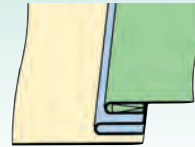
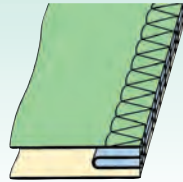

Giriş Cut Size mm	Çıkış Finish Size mm
22	10
25	12
30	15

OVERLOK MAKİNASI TIRNAKLI ARABIYE APERESİ ORNAMENT BINDING ATTACHMENT FOR OVERLOCK MACHINES

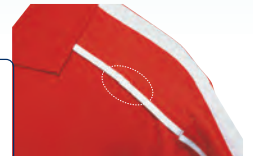
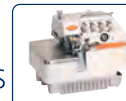

- Overlok makinaları için üretilir.
- Eşofmanlarda, şortlarda, tişörtlerde, ceketlerde ve montlarda kullanılır.
- İnce kumaşlar (M) için üretilir.

- Produced for overlock machines.
- Used on jogging suits, t-shirts, jackets and coats.
- Produced for light fabrics (M).

Giriş Cut Size mm	Çıkış Finish Size mm
20	10
25	12
30	15

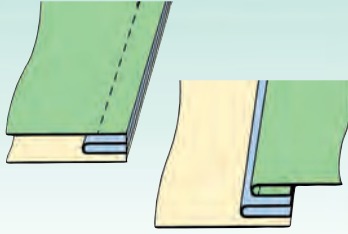

E 121

DÜZ MAKİNA ARABIYE APERESİ ORNAMENT BINDING ATTACHMENT FOR LOCKSTITCH MACHINES

- Düz Dikiş makinaları için üretilir.
- Eşofmanlarda, şortlarda, montların iç kısımlarında, ince kumaş pantolonlarda ve tişörtlerde kullanılır.
- Çok ince kumaşlar (L) ve ince kumaşlar (M) için üretilmiştir.
- Produced for lockstitch machines.
- Used on jogging suits, on the inner parts of the jackets, on the light fabric trousers and t-shirts.
- Produced for very light fabrics (L) and light fabrics (M).



Giriş Cut Size mm	Çıkış Finish Size mm
22	10
25	12
30	15

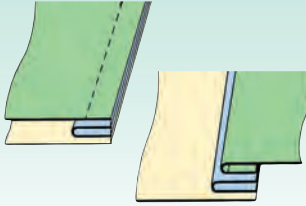

E 121A

DÜZ MAKİNA TIRNAKLI ARABIYE APERESİ ORNAMENT BINDING ATTACHMENT FOR LOCKSTITCH MACHINES

- Düz Dikiş makinaları için üretilir..
- Eşofmanlarda, şortlarda, tişörtlerde, ceketlerde ve montlarda kullanılır.
- İnce kumaşlar (M) için üretilir.
- Produced for lockstitch machines.
- Used on jogging suits, t-shirts, jackets and coats.
- Produced for light fabrics (M).



Giriş Cut Size mm	Çıkış Finish Size mm
20	10
25	12
30	15

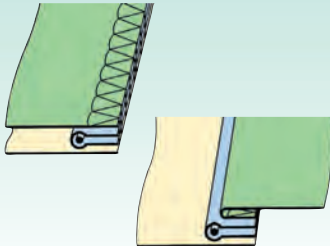

E 122

OVERLOK MAKİNASI İPLİ ARABIYE APERESİ ATTACHMENT OF ORNAMENT BINDING WITH YARN FOR OVERLOCK MACHINES

- Overlok makinaları için üretilir.
- Eşofmanlarda, şortlarda, montların iç kısımlarında, pantolonlarda ve tişörtlerde kullanılır.
- İnce kumaşlar (M) ve orta kumaşlar (MH) için üretilir.
- Makine ayağının altına kanal açılarak ipe kayması önlenir.
- Produced for overlock machines.
- Used on jogging suits, on the inner parts of the jackets, on light fabric trousers and t-shirts.
- Produced for light fabrics (M) and medium fabrics (MH).
- Sliding of the yarn is prevented by opening channel under the foot of the machine.



E 123



Giriş Cut Size mm	Çıkış Finish Size mm
20	10
25	12
30	15



DÜZ MAKİNE İPLİ ARABIYE APERESİ ATTACHMENT OF ORNAMENT BINDING WITH YARN FOR LOCKSTITCH MACHINES

- Düz Dikiş makinaları için üretilir.
- Eşofmanlarda, şortlarda, montların iç kısımlarında, ince kumaş pantolonlarda ve tişörtlerde kullanılır.
- İnce kumaşlar (M) için üretilmiştir.
- Altı kanallı ayak kullanılır.



- Produced for lockstitch machines.
- Used on jogging suits, on the inner parts of the jackets, on light fabric trousers and t-shirts.
- Produced for light fabrics (M).
- Foot with six channels is applied.

E 124

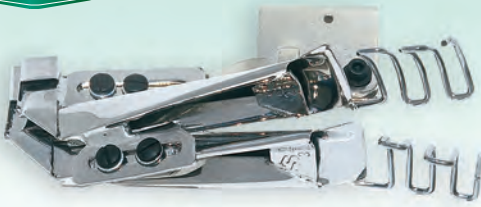

Giriş Cut Size mm	Çıkış Finish Size mm	Giriş Cut Size mm	Çıkış Finish Size mm
23	11	30	15

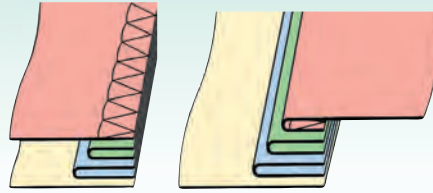

OVERLOK MAKİNASI ÇİFTLİ ARABIYE APERESİ ATTACHMENT OF DOUBLE ORNAMENT BINDING FOR OVERLOCK MACHINES

- Overlok makinaları için üretilir.
- Eşofmanlarda, şortlarda ve tişörtlerde kullanılır.
- İnce kumaşlar (M) için üretilir.



- Produced for overlock machines.
- Used on jogging suits, shorts and t-shirts.
- Produced for light fabrics (M).

E 124A



Giriş Cut Size mm	Çıkış Finish Size mm
25	12
30	15
35	17
40	20
45	22
50	25
55	27
60	30

OVERLOK MAKİNASI ÇİFT KATLAMA APERE OVERLOCK MACHINE DOUBLE FOLDING TAPE GUIDE ATTACHMENT

- Overlok makinaları için üretilmiştir.
- Tişörtlerde, yaka ve kol ağzlarında kullanılır.
- Çok ince kumaşlar (L) ve ince kumaşlar (M) için üretilmiştir.



- Produce for overlock machines.
- Used for collar and bottom parts of sleeves of t-shirts.
- Produced for very light fabrics (L) and light fabrics (M).

Giriş Cut Size mm	Çıkış Finish Size mm	Giriş Cut Size mm	Çıkış Finish Size mm
24	11	31	15

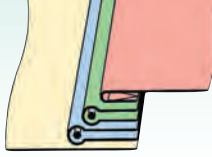
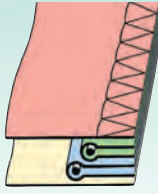

E 125

OVERLOK ÇİFTLİ İPLİ ARABIYE APERESİ ATTACHMENT OF ORNAMENT BINDING WITH DOUBLE YARN FOR OVERLOCK MACHINES



- Overlok makinaları için üretilir.
- Eşofmanlarda, şortlarda ve tişörtlerde kullanılır.
- İnce kumaşlar (M) için üretilir.
- Makina ayağının altına kanallar açılarak ipin kayması önlenir.
- Produced for overlock machines.
- Used on jogging suits, shorts and t-shirts.
- Produced for light fabrics (M).
- Sliding of the yarn is prevented by opening channels under the foot of the machine.

Giriş Cut Size mm	Çıkış Finish Size mm	Giriş Cut Size mm	Çıkış Finish Size mm
40	20	80	40
45	22	85	42
50	25	90	45
55	27	95	47
60	30	100	50
65	32	105	52
70	35	110	55
75	37	120	60



E126

OVERLOK MAKİNASI YAKA APERESİ COLLAR ATTACHMENT FOR OVERLOCK MACHINES



- Overlok makinaları için üretilir.
- Eşofmanlarda, şortlarda ve tişörtlerde kullanılır.
- İnce kumaşlar (M) için üretilir ve orta kumaşlar (MH) için üretilir.
- Produced for overlock machines.
- Used on jogging suits, shorts and t-shirts.
- Produced for the light fabrics (M) and medium fabrics (mH).

Giriş Cut Size mm	Çıkış Finish Size mm
30	15
35	17
40	20
45	22
50	25
60	30
70	35

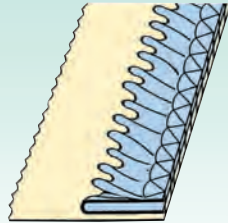

E 126A

TRANSPORTLU OVERLOK YAKA APERESİ COLLAR ATTACHMENT OF WALKING FOOT OVERLOCK



- Üstten Transportlu Overlok makinaları için üretilir.
- Bayan tişörtlerinin yaka kısımlarında kullanılır.
- İnce kumaşlar (M) için üretilir.
- Produced for overlock machines with upper walking foot.
- Used for collar parts of woman t-shirts.
- Produced for light fabrics (M).

E 126B

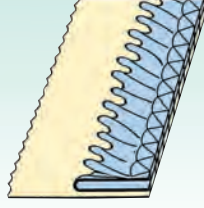

Giriş Cut Size mm	Çıkış Finish Size mm
50	25
55	27
60	30
65	32
70	35
75	37
80	40
85	42
90	45
95	47
100	50

TRANSPORTLU OVERLOK ÜSTTEN BURGULU YAKA APERESİ TOP FEED OVERLOCK MACHINE COLLAR WITH SPIRAL FROM TOP ATTACHMENT

- Üstten transportlu overlok makinaları için üretilmiştir.
- Bayan tişörtlerde, yaka ve kol ağızlarında kullanılır.
- Çok ince kumaşlar (L) ve ince kumaşlar (M) için üretilmiştir.

- Produced for top feed overlock machines.
- Used for collar and bottom parts of women's t-shirts.
- Produced for very light fabrics (L) and light fabrics (M).



E 127

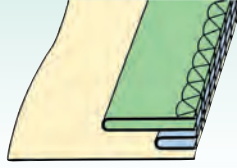

Arabiye Ornament Binding	
Giriş Cut Size mm	Çıkış Finish Size mm
25	12
30	15

Yaka Collar		Yaka Collar	
Giriş Cut Size mm	Çıkış Finish Size mm	Giriş Cut Size mm	Çıkış Finish Size mm
40	20	80	40
45	22	85	42
50	25	90	45
55	27	95	47
60	30	100	50
65	32	105	52
70	35	110	55
75	37	120	60

OVERLOK MAKİNASI SÜS BİYELİ YAKA APERESİ COLLAR ATTACHMENT WITH ORNAMENT BINDING FOR OVERLOCK MACHINES

- Overlok makinaları için üretilir.
- Tişörtlerin yaka kısımlarında kullanılır.
- İnce kumaşlar (M) ve orta kumaşlar (MH) için üretilir.

- Produced for overlock machines.
- Used on collars of the t-shirts.
- Produced for the light fabrics (M) and medium fabrics (MH).



E 128



Büyük Yaka Big Collar		Orta Yaka Medium Collar		Arabiye Ornament Binding	
Giriş Cut Size mm	Çıkış Finish Size mm	Giriş Cut Size mm	Çıkış Finish Size mm	Giriş Cut Size mm	Çıkış Finish Size mm
80	40	35	17	25	12
85	42	40	20	30	15
90	45	45	22		
95	47	50	25		
100	50	55	27		
105	52	60	30		
110	55	65	32		
120	60	70	35		

OVERLOK ÇİFT SÜSBİYELİ YAKA APERESİ COLLAR ATTACHMENT WITH DOUBLE ORNAMENT BINDING FOR OVERLOCK MACHINES

- Overlok makinaları için üretilir.
- Tişörtlerin yaka kısımlarında kullanılır.
- İnce kumaşlar (M) ve orta kumaşlar (MH) için üretilir.

- Produced for overlock machines.
- Used on collars of the t-shirts.
- Produced for light fabrics (M) and medium fabrics (MH).



Lastik Geniřliđi Rubber Size mm
13
23
38
50

E 129

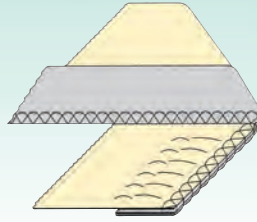

OVERLOK MAKİNASI ALTTAN LASTİKLİ APERESİ OVERLOCK MACHINE LOWER ATTACHMENT FOR RUBBER

- Overlok makinaları için üretilir.
- Eşofmanlarda, bayan eteklerinin ve şortların bel kısımlarında, eldivenlerde, çoraplarda, çadırlarda, araba kılıflarında çok amaçlı olarak kullanılır.
- Produced for overlock machines.
- Multi-purpose usage on joggings suits, on the waist parts of the lady's skirts and the shorts, on the gloves, socks, tents and car covers.



Lastik Geniřliđi Rubber Size mm
13
20
35
50
60
70
80
100

E 130

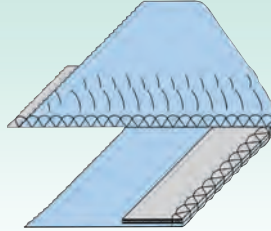

OVERLOK MAKİNASI ÜSTTEN LASTİK APERESİ OVERLOCK MACHINE UPPER ATTACHMENT FOR RUBBER

- Overlok makinaları için üretilir.
- Eşofmanlarda, bayan eteklerinin ve şortların bel kısımları başta olmak üzere çok amaçlı kullanılır.
- Ayađa lastik için tel monte edilir.
- Produced for overlock machines.
- Multi-purpose usage such as joggings suits, waist parts of ladies shirts.
- A wire is mounted to the foot for rubber.



Lastik Geniřliđi Rubber Size mm
20
35
50
60
70
80
100

E 131

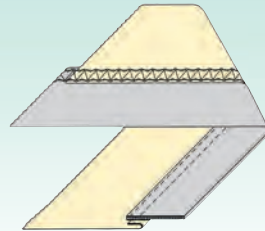

REÇME MAKİNASI ÜSTTEN LASTİK APERESİ INTERLOCK MACHINE UPPER ATTACHMENT FOR RUBBER

- Reçme makinaları için üretilmiştir.
- Eşofmanlarda, bayan eteklerinin ve şortların bel kısımları başta olmak üzere çok amaçlı kullanılır.
- Ayađa lastik için tel monte edilir.
- Produced for interlock machines.
- Multi-purpose usage such as joggings suits, waist parts of ladies shirts.
- A wire is mounted to the foot for rubber.



E 131A

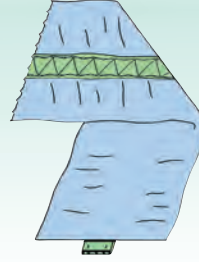

Lastik Geniřlięi
Rubber Size
mm

6
8
10
12
15

REÇME MAKİNASI ALTTAN LASTİK APERESİ INTERLOCK MACHINE ELASTIC FROM BOTTOM ATTACHMENT



- Reçme etek makinaları için üretilmiştir.
- Penye ve tişörtlerin kol ve etek kısımlarında kullanılır.

- Produced for plain seaming interlock machines.
- Used for sleeve and hem parts of combed cotton dresses and t-shirts.

T 132

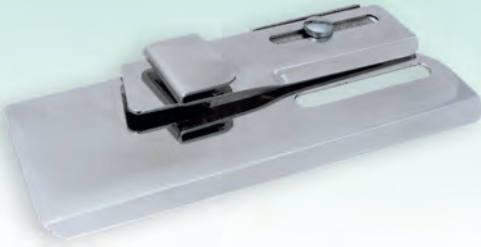

REÇME MAKİNASI LOK APERESİ LOCK ATTACHMENT FOR INTERLOCK MACHINES



- Reçme Lok makinası için üretilmiştir.
- Tişörtlerde ve kilotlarda kullanılır.
- İğne aralıklarına göre genişlik ayarı yapılır.

- Produced for interlock lock machines.
- Used on t-shirts and underpants.
- Width adjustment can be done in accordance with the needle interval.

T 132A



REÇME MAKİNASI SOLDAN LOK APERESİ LEFT SIDE LOCK ATTACHMENT FOR INTERLOCK MACHINES



- Reçme Lok makinası için üretilmiştir.
- Tişörtlerde ve kilotlarda kullanılır.
- İğne aralıklarına göre genişlik ayarı yapılır.

- Produced for interlock lock machines.
- Used on t-shirts and underpants.
- Width adjustment can be done in accordance with the needle interval.

T 133A

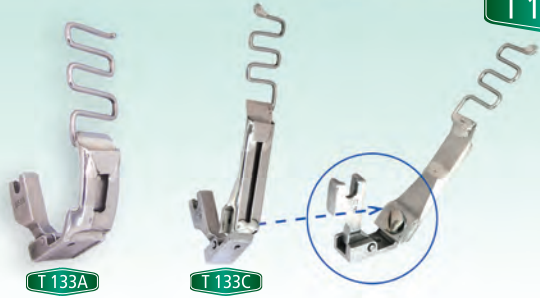
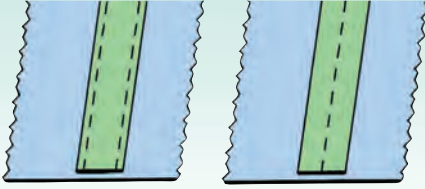

AYAĞA DÜZ ŞERİT APERESİ FLAT RIBBON ATTACHMENT

- Düz Dikiş Makinası, çiftliğine dikiş makinası, reçme makinası ve şerit makinaları için üretilmiştir.
- Çok amaçlı kullanım alanları vardır.
- Sipariş edilen tüm ölçüler için üretilir.

- Produced for lockstitch sewing machines, double needle sewing machines, interlock machines and ribbon machines.
- Multi-purpose usage.
- Produced for all sizes ordered.



T 133B

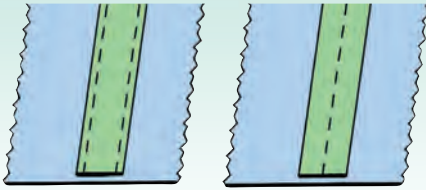

DÜZ ŞERİT APERESİ FLAT RIBBON ATTACHMENT

- Düz Dikiş Makinası, çiftliğine dikiş makinası, reçme makinası ve şerit makinaları için üretilmiştir.
- Çok amaçlı kullanım alanları vardır.
- Sipariş edilen tüm ölçüler için üretilir.

- Produced for lockstitch sewing machines, double needle sewing machines, interlock machines and ribbon machines.
- Multi-purpose usage.
- Produced for all sizes ordered.



Giriş Cut Size mm	Çıkış Finish Size mm	Giriş Cut Size mm	Çıkış Finish Size mm
25	6	45	14
28	7	50	15
30	7	50	16
30	8	55	18
35	9	60	20
35	10	65	22
40	10	70	25
40	12	80	30

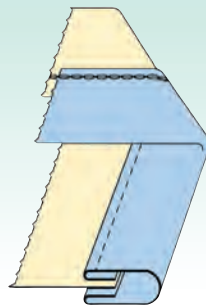

T 134



ÇİFT KIVIRMA REÇME APERESİ DOUBLE FOLDING INTERLOCK ATTACHMENT

- Reçme bant makinaları için üretilmiştir.
- Penye, atlet ve tişörtlerin kol ve yaka kısımlarında kullanılır.

- Produced for interlock stitch tape binding machines.
- Used for sleeve and hem parts of combed cotton dresses, underwears and t-shirts.

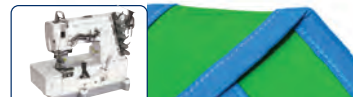

T 135

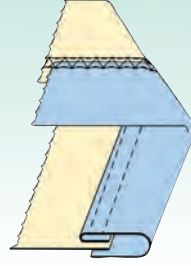

Giriş Cut Size mm	Çıkış Finish Size mm
25	8
30	10
32	12
35	13
40	15
45	18
50	20
55	22
60	25
65	27
70	30

TEK KIVIRMA REÇME APERESİ SINGLE FOLDING INTERLOCK ATTACHMENT

- Reçme bant makinaları için üretilmiştir.
- Penye, atlet ve tişörtlerin kol ve yaka kısımlarında kullanılır.

- Produced for interlock stitch tape binding machines.
- Used for sleeve and hem parts of combed cotton dresses, underwears and t-shirts.

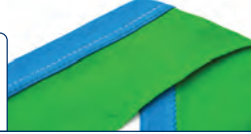

T 136

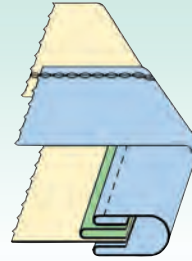

Giriş Cut Size mm	Çıkış Finish Size mm	Arabeye Ornament Binding	
25	6	18	8
28	7		
30	7		
30	8		
35	9		
35	10	22	10
40	10		
40	12		
45	14		
50	15		
50	16		
55	18		
60	20	25	12
65	22		
70	25		

ARABİYELİ ÇİFT KIVIRMA REÇME APERESİ DOUBLE FOLDING WITH ORNAMENT BINDING INTERLOCK ATTACHMENT

- Reçme bant makinaları için üretilmiştir.
- Penye, atlet ve tişörtlerin kol ve yaka kısımlarında kullanılır.

- Produced for interlock stitch tape binding machines.
- Used for sleeve and hem parts of combed cotton dresses, underwears and t-shirts.



T 137

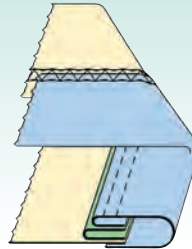

Giriş Cut Size mm	Çıkış Finish Size mm	Arabeye Ornament Binding	
25	8	18	8
30	10		
32	12		
35	13		
40	15		
40	15	22	10
45	18		
50	20		
55	22		
60	25		
65	27		
70	30		
65	27	25	12
70	30		

ARABİYELİ TEK KIVIRMA REÇME APERESİ SINGLE FOLDING WITH ORNAMENT BINDING INTERLOCK ATTACHMENT

- Reçme bant makinaları için üretilmiştir.
- Penye, atlet ve tişörtlerin kol ve yaka kısımlarında kullanılır.

- Produced for interlock stitch tape binding machines.
- Used for sleeve and hem parts of combed cotton dresses, underwears and t-shirts.



T 138

Giriş Cut Size mm	Çıkış Finish Size mm
15	7
20	10
25	12
30	15
35	17
40	20
45	22
50	25
55	27
60	30
65	32
70	35

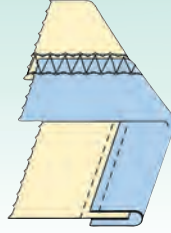

İKİYE KATLAMA REÇME APERESİ INTERLOCK ATTACHMENT FOR DOUBLE BINDING

- Reçme Bant makinaları için üretilmiştir.
- Tişörtlerde ve atletlerde kullanılır.



- Produced for tape binding interlock machines.
- Used on the t-shirts and top underwears.

T 138A

Giriş Cut Size mm	Çıkış Finish Size mm
15	7
20	10
25	12
30	15
35	17
40	20
45	22
50	25
55	27
60	30
65	32
70	35

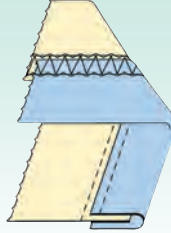

İKİYE KATLAMA ETEK REÇME APERESİ DOUBLE FOLDING INTERLOCK ATTACHMENT FOR PLAIN SEAMING

- Reçme Etek makinaları için üretilmiştir.
- Tişörtlerde ve atletlerde kullanılır.



- Produced for plain seaming interlock machines.
- Used on the t-shirts and top underwears.

Aperes Attachment		Serit Aperesi Ribbon Atta.	
Giriş Cut Size mm	Çıkış Finish Size mm	Giriş Cut Size mm	Çıkış Finish Size mm
15	7	15	6
20	10	18	8
25	12	22	10
30	15		
35	17		
40	20		
50	25		
55	27		
60	30		
70	35		

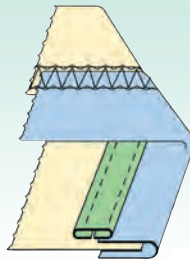

T 139

ŞERİTLİ İKİYE KATLAMALI REÇME APERESİ DOUBLE FOLDING ATTACHMENT FOR INTERLOCK WITH RIBBON

- Reçme Bant makinaları için üretilir.
- Tişörtlerde kullanılır.



- Produced for tape binding interlock machines.
- Used on the t-shirts.

T 140

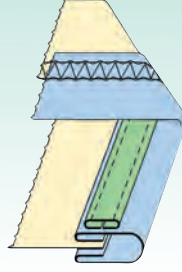

Aper Attachment		Serit Ribbon	
Giriş Cut Size mm	Çıkış Finish Size mm	Giriş Cut Size mm	Çıkış Finish Size mm
35	10	15	6
40	12	18	8
45	14	22	10
50	16		
55	18		
60	20		
65	22		
70	25		

ŞERİTLİ ÇİFT KIVIRMA REÇME APERESİ DOUBLE FOLDING ATTACHMENT FOR INTERLOCK WITH RIBBON

- Reçme bant makinaları için üretilmiştir.
- Tişörtlerde kullanılır.

- Produced for tape binding interlock machines.
- Used on the t-shirts.



T 141

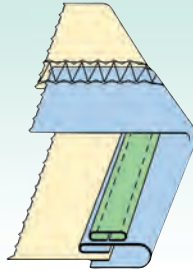

Aper Attachment		Serit Ribbon	
Giriş Cut Size mm	Çıkış Finish Size mm	Giriş Cut Size mm	Çıkış Finish Size mm
30	10	15	6
35	13	18	8
40	15	22	10
45	18		
50	20		
60	25		
70	30		
80	35		

ŞERİTLİ TEK KIVIRMA REÇME APERESİ SINGLE FOLDING ATTACHMENT FOR INTERLOCK WITH RIBBON

- Reçme bant makinaları için üretilir.
- Tişörtlerde ve atletlerde kullanılır.

- Produced for tape binding interlock machines.
- Used on the t-shirts and top underwears.



T 142A

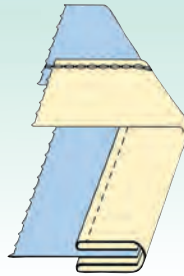

Giriş Cut Size mm	Çıkış Finish Size mm
40	10
50	12
60	15
80	20

TAM KATLAMA ÇİFT KIVIRMA REÇME APERESİ COMPLETE BENT DOUBLE FOLDING INTERLOCK ATTACHMENT

- Reçme bant makinaları için üretilir.
- Tişörtler, aletler, mayolar, sütyenler ve abiye kıyafetler başta olmak üzere çok amaçlı kullanılır.
- Açık renkli kumaşları tam katlayarak koyu bedenler üzerinde hoş görünmesini sağlar.
- Saten, Likralı ve benzeri kumaşlarda tercih edilir.

- Produced for tape binding interlock machines.
- Multi-purpose usage such as t-shirts, top underwears, bathing suits, brassieres, and fashion garments
- Ensures nice looking of light colored fabrics by complete folding.
- Preferred on the satin, lycra fabrics and similars.



T 142

Giriş Cut Size mm	Çıkış Finish Size mm	Giriş Cut Size mm	Çıkış Finish Size mm
25	6	55	18
30	7	60	20
30	8	65	22
35	9	70	25
35	10	80	30
40	12	90	35
45	14	100	40
50	15		
50	16		

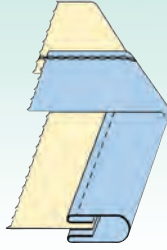

KAPALI ÇİFT KIVIRMA REÇME APERESİ COVERED DOUBLE FOLDING ATTACHMENT OF INTERLOCK

- Reçme bant makineleri için üretilir.
- Tişörtler, aletler, mayolar, sütyenler ve abiye kıyafetler başta olmak üzere çok amaçlı kullanılır.
- Saten, Likralı ve benzeri kumaşlarda tercih edilir.
- Produced for tape binding interlock machines.
- Multi-purpose usage such as t-shirts, top underwears, bathing suits, brassieres, and fashion garments.
- Preferred on the satin, lycra fabrics and similars.

T 143

Giriş Cut Size mm	Çıkış Finish Size mm
25	8
30	10
32	12
35	13
40	15
45	18
50	20
60	25
70	30
80	35
90	40

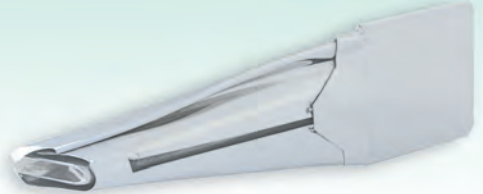
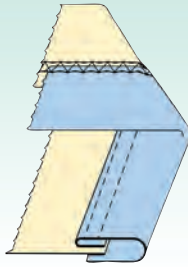

KAPALI TEK KIVIRMA REÇME APERESİ COVERED SINGLE FOLDING ATTACHMENT OF INTERLOCK

- Reçme Bant makineleri için üretilir.
- Tişörtler, aletler, mayolar ve abiye kıyafetler başta olmak üzere çok amaçlı kullanılır.
- Saten, Likralı ve benzeri kumaşlarda tercih edilir.
- Produced for tape binding interlock machines.
- Multi-purpose usage such as t-shirts, top underwears, bathing suits and fashion garments.
- Preferred on the satin, lycra fabrics and similars.

T 143A

Giriş Cut Size mm	Çıkış Finish Size mm
30	10
36	12
45	15
60	20

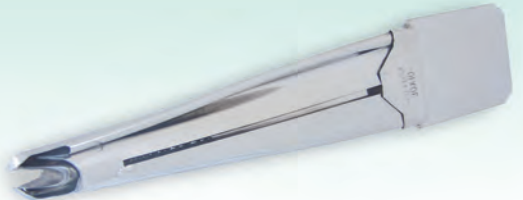
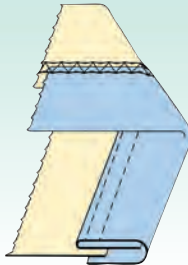

TAM KATLAMA TEK KIVIRMA REÇME APERESİ COMPLETE BENT SINGLE FOLDING INTERLOCK ATTACHMENT

- Reçme Bant makineleri için üretilir.
- Tişörtler, aletler, mayolar ve abiye kıyafetler başta olmak üzere çok amaçlı kullanılır.
- Açık renkli kumaşları tam katlayarak koyu bedenler üzerinde hoş görünmesini sağlar.
- Saten, Likralı ve benzeri kumaşlarda tercih edilir.
- Produced for tape binding interlock machines.
- Multi-purpose usage such as t-shirts, top underwears, bathing suits, brassieres, and fashion garments.
- Ensures nice looking of light colored fabrics by complete folding.
- Preferred on the satin, lycra fabrics and similars.

T 143B

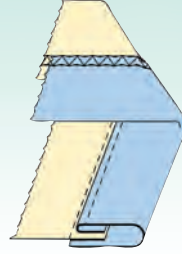
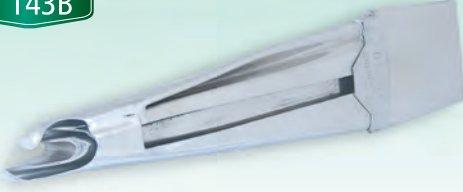

Giriş Cut Size mm	Çıkış Finish Size mm
30	8
35	10
40	13
45	15
50	18
60	20
70	25
80	30
90	35
95	40

ALTI İLERDE TEK KIVIRMA REÇME APERESİ BOTTOM FORWARD SINGLE FOLDING INTERLOCK ATTACHMENT

- Reçme bant makinaları için üretilir.
- Tişörtlerde ve atletlerde kullanılır.

- Produced for tape binding interlock machines.
- Used on t-shirts and top underwears.



T 143C

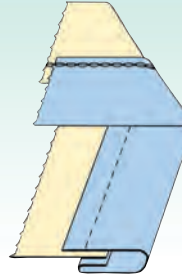
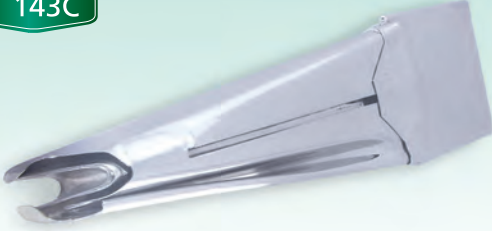

Giriş Cut Size mm	Çıkış Finish Size mm
30	8
35	10
40	13
45	15
50	18
60	20
70	25
80	30
90	35
95	40

TERS TEK KIVIRMA REÇME APERESİ REVERSE SINGLE FOLDING INTERLOCK ATTACHMENT

- Reçme bant makinaları için üretilir.
- Tişörtlerde ve atletlerde kullanılır.

- Produced for tape binding interlock machines.
- Used on t-shirts and top underwears.



T 144A

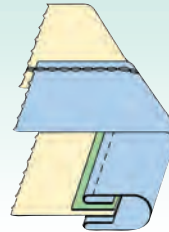

Aperde Attachment		Arabiye Ornament Binding
Giriş Cut Size mm	Çıkış Finish Size mm	Giriş Cut Size mm
30	8	
35	10	
40	12	8
45	14	10
50	16	12
55	18	15
60	20	
65	22	
70	25	

DÜZ ARABİYELİ ÇİFT KIVIRMA REÇME APERESİ FLAT ORNAMENT BINDING DOUBLE FOLDING INTERLOCK ATTACHMENT

- Reçme bant makinaları için üretilir.
- Tişörtlerde kullanılır.

- Produced for tape binding interlock machines.
- Used on t-shirts.



Aperde Attachment		Arabiye Ornament Binding		Aperde Attachment		Arabiye Ornament Binding	
Giriş Cut Size mm	Çıkış Finish Size mm	Giriş Cut Size mm	Çıkış Finish Size mm	Giriş Cut Size mm	Çıkış Finish Size mm	Giriş Cut Size mm	Çıkış Finish Size mm
30	8	18	8	60	20	25	12
35	10			65	22		
40	12			70	25		
45	14	22	10	80	30		
50	16			90	35		
55	18			100	40		

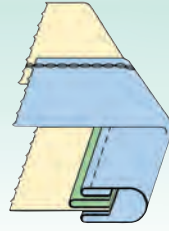

T 144

KAPALI SÜS BİYELİ ÇİFT KIVIRMA REÇME APERESİ COVERED DOUBLE FOLDING ATTACHMENT FOR INTERLOCK WITH ORNAMENT BINDING

- Reçme bant makinaları için üretilmiştir.
- Tişörtler ve mayolar başta olmak üzere çok amaçlı kullanılır.
- Saten, Likralı ve benzeri kumaşlarda tercih edilir.

- Produced for tape binding interlock machines.
- Multi-purpose usage such as t-shirts and bathing suits.
- Preferred on the satin, lycra fabrics and similars.



Aperde Attachment		Arabiye Ornament Binding	
Giriş Cut Size mm	Çıkış Finish Size mm	Giriş Cut Size mm	Çıkış Finish Size mm
25	8	18	8
30	10		
35	13		
40	15	22	10
45	18		
50	20		
60	25		
70	30	25	12
80	35		
90	40		

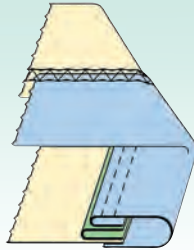

T 145

KAPALI SÜS BİYELİ TEK KIVIRMA REÇME APERESİ COVERED SINGLE FOLDING ATTACHMENT FOR INTERLOCK WITH ORNAMENT BINDING

- Reçme bant makinaları için üretilmiştir.
- Tişörtler ve mayolar başta olmak üzere çok amaçlı kullanılır.

- Produced for tape binding interlock machines.
- Multi-purpose usage such as t-shirts and bathing suits.

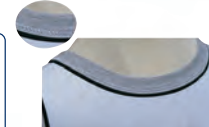

Aperde Attachment		Arabiye Ornament Binding	
Giriş Cut Size mm	Çıkış Finish Size mm	Giriş Cut Size mm	
25	8	8	
30	10		
35	13		
40	15		
45	18		
50	20		
60	25		
70	30		
80	35		
90	40		

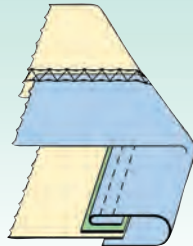

T 145A

DÜZ ARABİYELİ TEK KIVIRMA REÇME APERESİ FLAT ORNAMENT BINDING SINGLE FOLDING INTERLOCK ATTACHMENT

- Reçme bant makinaları için üretilir.
- Tişörtlerde kullanılır.

- Produced for tape binding interlock machines.
- Used on the t-shirts.



T 146

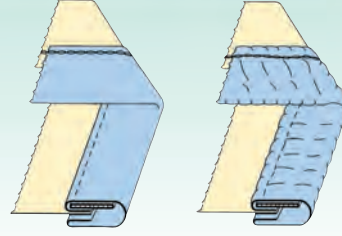

Giriş Cut Size mm	Çıkış Finish Size mm
30	8
35	10
40	12
45	14
50	16
55	18
60	20

KAPALI LASTİKLİ ÇİFT KIVIRMA REÇME APERESİ COVERED DOUBLE FOLDING ATTACHMENT FOR INTERLOCK WITH RUBBER

- Reçme Bant makinaları için üretilmiştir.
- Mayolar, sütyenler ve abiye kıyafetler başta olmak üzere çok amaçlı kullanılır.
- Saten, Likralı ve benzeri kumaşlarda tercih edilir.

- Produced for tape binding interlock machines.
- Multi-purpose usage such as bathing suits, brassieres and fashion garments.
- Preferred on the satin, lycra fabrics and similars.



T 147

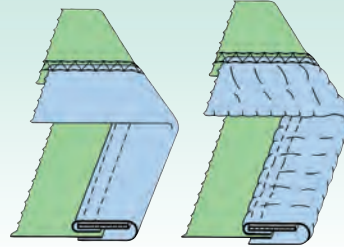
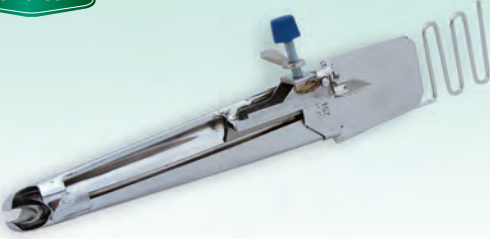

Giriş Cut Size mm	Çıkış Finish Size mm
25	8
30	10
35	13
40	15
45	18
50	20
60	25

KAPALI LASTİKLİ TEK KIVIRMA REÇME APERESİ COVERED SINGLE FOLDING ATTACHMENT OF INTERLOCK WITH RUBBER

- Reçme bant makinaları için üretilmiştir.
- Mayolar, sütyenler ve abiye kıyafetler başta olmak üzere çok amaçlı kullanılır.
- Saten, Likralı ve benzeri kumaşlarda tercih edilir.

- Produced for tape binding interlock machines.
- Used with multi purposes, bathing suits, brassieres and fashion garments being on top.
- Preferred on the satin, lycra fabrics and similars.



T 148

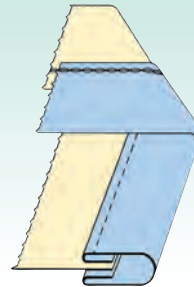

Giriş Cut Size mm	Çıkış Finish Size mm
30	8
35	10
40	12
45	14
50	16
55	18
60	20

ÇİFT KIVIRMA ETEK REÇME BANT APARESİ DOUBLE FOLDING TAPE ATTACHMENT FOR PLAIN SEAMING INTERLOCK

- Reçme etek makinaları için üretilmiştir.
- Tişörtlerde ve atletlerde kullanılır.

- Produced for plain seaming interlock machines.
- Used on t-shirts and top underwears.



Giriş Cut Size mm	Çıkış Finish Size mm
25	8
30	10
35	13
40	15
45	18
50	20
60	25

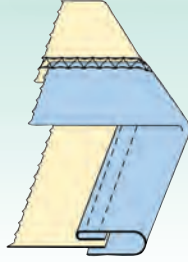

T 149



TEK KIVIRMA ETEK REÇME BANT APERESİ SINGLE FOLDING TAPE ATTACHMENT FOR PLAIN SEAMING INTERLOCK

- Reçme etek makinaları için üretilmiştir.
- Tişörtlerde ve atletlerde kullanılır.

- Produced for plain seaming interlock machines.
- Used on t-shirts and top underwears.



Apere Attachment		Arabiye Ornament Binding	
Giriş Cut Size mm	Çıkış Finish Size mm	Giriş Cut Size mm	Çıkış Finish Size mm
30	8	18	8
35	10		
40	10		
40	12	22	10
45	14		
50	16		
55	18		
60	20	25	12

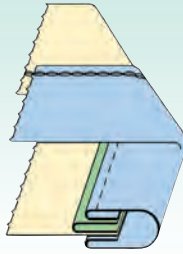

T 150



SÜSBİYELİ ÇİFT KIVIRMA ETEK BANT APERESİ DOUBLE FOLDING TAPE ATTACHMENT FOR PLAIN SEAMING WITH INT. ORNAMENT BINDING

- Reçme etek makinaları için üretilmiştir.
- Tişörtlerde kullanılır.

- Produced for plain seaming interlock machines.
- Used on t-shirts .



Apere Attachment		Arabiye Ornament Binding	
Giriş Cut Size mm	Çıkış Finish Size mm	Giriş Cut Size mm	Çıkış Finish Size mm
25	8	18	8
30	10		
35	13		
40	15	22	10
45	18		
50	20		
60	25	25	12
70	30		

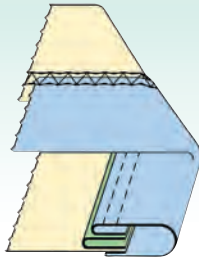

T 151



SÜSBİYELİ TEK KIVIRMA ETEK BANT APERESİ SINGLE FOLDING TAPE ATTACHMENT FOR PLAIN SEAMING INT. WITH INTERVAL BINDING

- Reçme etek makinaları için üretilir.
- Tişörtlerde kullanılır.

- Produced for plain seaming interlock machines.
- Used on t-shirts .

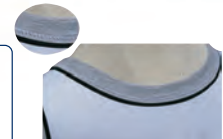

T 152

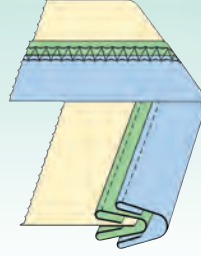

İç Apere Internal Atta.		Dış Apere External Atta.	
Giriş Cut Size mm	Çıkış Finish Size mm	Giriş Cut Size mm	Çıkış Finish Size mm
35	10	45	14

ÇİFTLİ ÇİFT KIVIRMA REÇME APERESİ

ATTACHMENT OF TAPE INTERLOCK DOUBLE FOLDING IN DOUBLE

- Reçme bant makinaları için üretilir.
- Tişörtlerde kullanılır.

- Produced for interlock ribbon machines.
- Used on t-shirts .



T 153

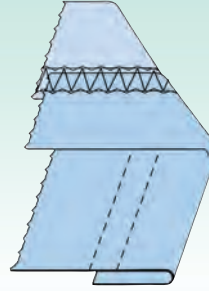

ÇİFT PARÇALI REÇME ETEK APERESİ

INTERLOCK ATTACHMENT WITH TWO PIECES

- Reçme etek makinaları için üretilir.
- Başta tişörtlerde ve atletlerin etek kısımları olmak üzere çok amaçlı kullanım alanları vardır.

- Produced for plain seaming interlock machines.
- Multi-purpose usage such as the t-shirts and the bottom parts of the top underwears.



T 153A

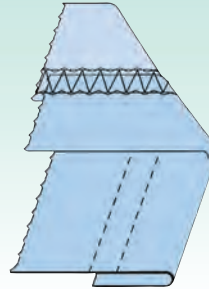
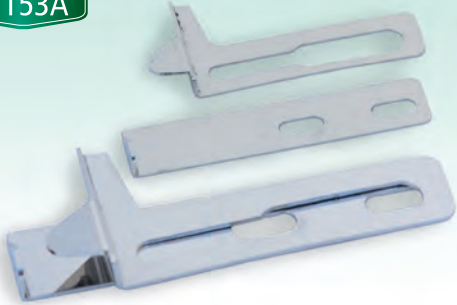

BURUNLU REÇME ETEK APERESİ

CYLINDER BED PLAIN SEAMING INTERLOCK ATTACMENT

- Burunlu reçme etek makinaları için üretilir.
- Başta tişörtlerde ve atletlerin etek kısımları olmak üzere çok amaçlı kullanım alanları vardır.

- Produced for plain seaming cylinder bed.
- Multi-purpose usage such as the t-shirts and the bottom parts of the top underwears.



Çıkış
Finish
Size
mm
20
25

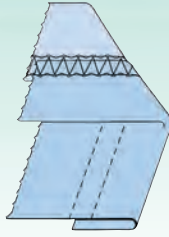

T 153B



REÇME MAKİNASI ETEK KIVIRMA APERESİ PLAIN SEAMING INTERLOCK FOLDING ATTACHMENT

- Reçme etek makinaları için üretilmiştir.
- Başta Tişört ve Atletlerin etek kısımları başta olmak üzere çok amaçlı olarak kullanım alanları vardır.

- Produced for plain seaming interlock machines.
- Multi-purpose usage such as t-shirts and the bottom parts of the top underwears.



Çıkış
Finish
Size
mm

13 ← → 45

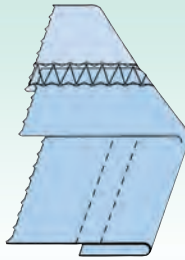

T 154



REÇME MAKİNASI AYARLI ETEK APERESİ ADJUSTABLE PLAIN SEAMING INTERLOCK FOLDING ATTACHMENT

- Reçme etek makinaları için üretilmiştir.
- Başta Tişört ve Atletlerin etek kısımları başta olmak üzere çok amaçlı olarak kullanım alanı vardır.

- Produced for plain seaming interlock machines.
- Multi-purpose usage such as t-shirts and the bottom parts of the top underwears.



Çıkış
Finish
Size
mm

8

10

12

15

18

20

22

25

28

30

Çıkış
Finish
Size
mm

32

35

38

40

42

45

48

50

52

55

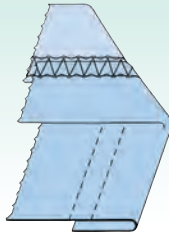

T 155



REÇME MAKİNASI ETEK KIVIRMA APERESİ PLAIN SEAMING INTERLOCK FOLDING ATTACHMENT

- Reçme etek makinaları için üretilmiştir.
- Başta Tişört ve Atletlerin etek kısımları başta olmak üzere çok amaçlı olarak kullanım alanları vardır.

- Produced for plain seaming interlock machines.
- Multi-purpose usage such as the t-shirts and the bottom parts of the top underwears.



T 155A

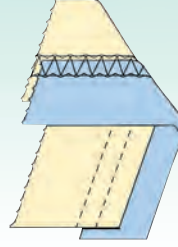

Biye Geniřliđi Binding Width mm
23
38
50

BİYELİ ETEK APERESİ HEMMER WITH BINDING ATTACHMENT

- Etek reçme makinaları için üretilir.
- Penye ve Tişörtlerin kol ve etek kısımlarında kullanılır
- Alt biye ve beden kısmı genişliğe göre ayarlanabilir.



- Produced for plain seaming interlock machines.
- Used on sleeve and bottom parts of t-shirts and combed cotton products.
- Adjustable according to bottom binding and body part wideness.

T 155B

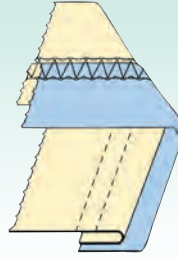

Beden Kıvrılması Body Folding mm	Biye Geniřliđi Binding Width mm
15	23
20	38
25	50

ÜST KIVIRMALI BİYELİ ETEK APERESİ UPPER FOLDED HEMMER WITH BINDING ATTACHMENT

- Etek reçme makinaları için üretilir.
- Penye ve Tişörtlerin kol ve etek kısımlarında kullanılır
- Alt biye genişliğe göre ayarlanabilir.



- Produced for plain seaming interlock machines.
- Used on sleeve and bottom parts of t-shirts and combed cotton products.
- Bottom binding can be adjusted according to wideness.

T 155C

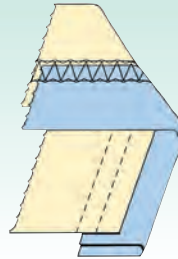

Giriş Cut Size mm	Çıkış Finish Size mm
50	25
55	27
60	30
65	32
70	35
75	37
80	40

ALT TEMİZ KATLAMA ETEK APERESİ CLEAR BOTTOM FOLDING HEMMED ATTACHMENT

- Etek reçme makinaları için üretilir.
- Penye ve Tişörtlerin kol ve etek kısımlarında kullanılır
- Beden kısmı ayarlanabilir.

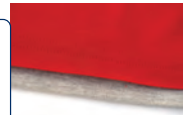

- Produced for plain seaming interlock machines.
- Used on sleeve and bottom parts of t-shirts and combed cotton products.
- Body part can be adjusted.

Beden Kıvrılması Body Folding mm	Giriş Cut Size mm	Çıkış Finish Size mm
15	50	25
20	55	27
25	60	30
	65	32
	70	35
	75	37
	80	40

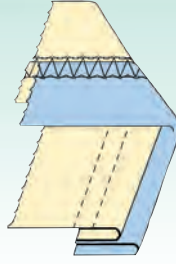

T 155D

TEMİZ KATLAMA ETEK APERESİ CLEAR FOLDING HEMMER ATTACHMENT



- Etek reçme makinaları için üretilir.
- Penye ve Tişörtlerin kol ve etek kısımlarında kullanılır

- Produced for plain seaming interlock machines.
- Used on sleeve and bottom parts of t-shirts and combed cotton products.

Giriş Cut Size mm	Çıkış Finish Size mm
30	15
35	17

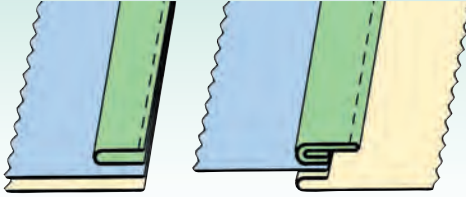

T 156

TIŞÖRT YAKA APERESİ T-SHIRT COLLAR ATTACHMENT



- Düz dikiş makinaları için üretilir.
- Tişörtlerin yaka kısımlarında kullanılır.
- Ayak değiştirilir.

- Produced for lockstitch sewing machines.
- Used on the collar parts of t-shirts.
- The foot can be changed.

Giriş Cut Size mm	Çıkış Finish Size mm
22	9
28	12

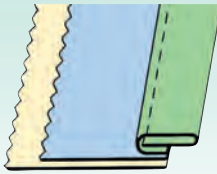

T 157

TIŞÖRT YAKA BİYE APERESİ T-SHIRT COLLAR BINDING ATTACHMENT



- Düz dikiş makinaları için üretilir.
- Tişörtlerin yaka kısımlarında kullanılır.
- Ayak değiştirilir.

- Produced for lockstitch sewing machines.
- Used on the collar parts of the t-shirts.
- The foot can be changed.

T 158

Lastik Geniřliđi Rubber Size mm
6
7
8
9
10
12
15



T 158A

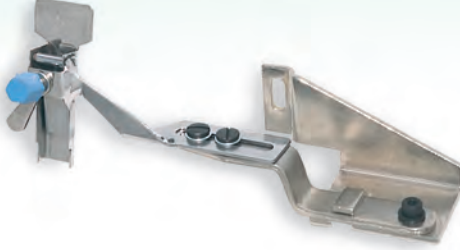

T 158

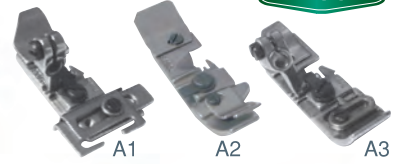

T 158B



T 158C

Lastik Geniřliđi Rubber Size mm
13
23
38
50

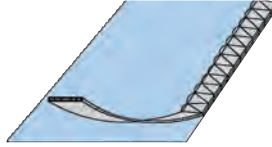

T 158D

OVERLOK MAKİNASI EKSTRAFOR APERESİ TAPE BINDING ATTACHMENT FOR OVERLOCK MACHINES



- Overlok makinası için üretilir.
- Penye ve tişörtlerin omuz kısımlarında kullanılır.
- Overlok makinasının ayağına ekstrafor genişliğinde kanal açılıp, köprü yapılır.

- Produced for overlock machines.
- Used on the shoulder parts of t-shirts and combed items.
- A channel with the same width of the band is opened on the foot of the overlock machine and a metal part is mounted.

T 158E

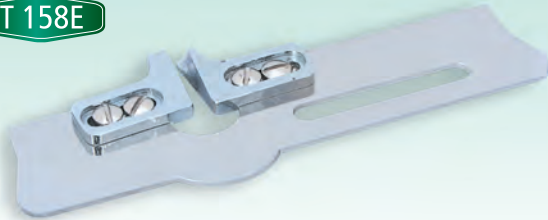

REÇME ETEK MAKİNASI OVERLOK DİKİŐİ YATIRMA SİPERİ PLAIN SEAMING INTERLOCK MACHINE OVERLOCK STITCH LAYING PLATE



- Reçme etek makinaları için üretilir
- Penye ve Tişörtlerde omuz ve yan kısımlarında kullanılır.
- Overlok çatımlarını yatırıp çıma atmada kullanılır.

- Produced for plain seaming interlock machines.
- Used on shoulder and side parts of t-shirts and combed cotton items.
- Used for laying and sewing overlock stitched parts.

Kumaş Kalınlığı
Thick Material Size

L
M
MH



T 159

DÜZ MAKİNA YAN ÇATMA APERESİ LOCK STITCH MACHINE SIDE STITCHING ATTACHMENT

- Düz dikiş makinaları için üretilmiştir.
- Eşortmanlar başta olmak üzere çok amaçlı kullanım alanları vardır.
- Ayakları değiştirilir.
- Produced for lockstitch sewing machines.
- Multi-purpose usage such as jogging suits.
- The foot can be changed.



Giriş Cut Size mm	Çıkış Finish Size mm
20	9
25	12

Kumaş Kalınlığı
Thick Material Size

L
M

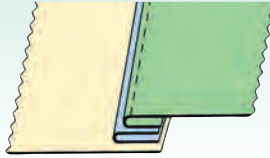

T 160

DÜZ MAKİNA ALTI AÇIK BİYELİ ÇATMA APERESİ SIDE STITCHING ATTACHMENT FOR LOCKSTITCH MACHINES WITH INTERVAL BINDING ON THE BOTTOM

- Düz dikiş makinaları için üretilir.
- Eşortmanlar başta olmak üzere çok amaçlı kullanım alanları vardır.
- Ayakları değiştirilir.
- Produced for lockstitch sewing machines.
- Multi-purpose usage such as jogging suits.
- The foot can be changed.



Giriş Cut Size mm	Çıkış Finish Size mm
20	8
25	11

Kumaş Kalınlığı
Thick Material Size

L
M

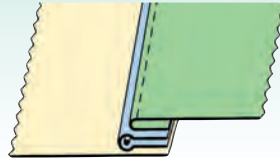

T 161

DÜZ MAKİNA ALTI AÇIK İPLİ ÇATMA APERESİ SIDE STITCHING ATTACHMENT FOR LOCKSTITCH MACHINES WITH INTERVAL BINDING ON THE BOTTOM YARN

- Düz dikiş makinaları için üretilir.
- Eşortmanlar başta olmak üzere çok amaçlı kullanım alanları vardır.
- Altı kanallı ayak kullanılır.
- Produced for lockstitch sewing machines.
- Multi-purpose usage such as jogging suits.
- Foot with six channels is applied.

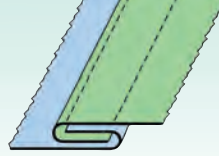

T 162

Kumaş Kalınlığı
Thick Material Size

M

MH

ÇİFT İĞNE ÇATMA APERESİ

ATTACHMENT WITH ARM FOR DOUBLE NEEDLE MACHINES

- Çift iğne dikiş makinaları için üretilir.
- Eşortmanlar başta olmak üzere çok amaçlı kullanım alanları vardır.

- Produced for double needle sewing machines.
- Multi-purpose usage such as jogging suits, tents and canvas.

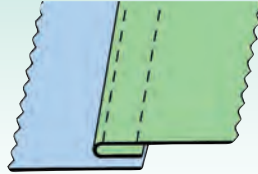

T 163

Kumaş Kalınlığı
Thick Material Size

M

MH

ALTI AÇIK ÇİFT İĞNE ÇATMA APERESİ

BOTTOM OPEN DOUBLE NEEDLE SIDE STITCHING ATTACHMENT

- Çift iğne dikiş makinaları için üretilir.
- Eşortmanlar başta olmak üzere çok amaçlı kullanım alanları vardır.

- Produced for double needle sewing machines.
- Multi-purpose usage such as jogging suits.

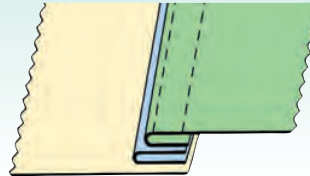

T 164

Arabiye
Ornament BindingGiriş
Cut
Size
mmÇıkış
Finish
Size
mm

18 8

20 9

Kumaş Kalınlığı
Thick Material Size

M

MH

ARABİYELİ ÇATMA APERESİ

SIDE STITCHING ATTACHMENT WITH ORNAMENT BINDING

- Çift zincir dikiş kollu makinaları için üretilir.
- Eşortmanlar başta olmak üzere çok amaçlı kullanım alanları vardır.

- Produced for double chain sewing machines with arm.
- Multi-purpose usage such as jogging suits.



Arabiye Ornament Binding

Giriş Cut Size mm	Çıkış Finish Size mm
18	7
20	8

Kumaş Kalınlığı
Thick Material Size

M
MH

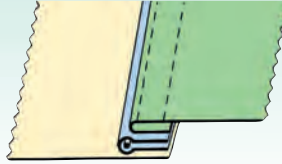

T 165



İPLİ ARABİYELİ ÇATMA APERESİ

SIDE STITCHING ATTACHMENT WITH YARN AND ORNAMENT BINDING

- Çift zincir dikiş kollu makineleri için üretilir.
- Eşortmanlar başta olmak üzere çok amaçlı kullanım alanları vardır.

- Produced for double chain sewing machines with arm.
- Multi-purpose usage such as jogging suits



Arabiye Ornament Binding

Giriş Cut Size mm	Çıkış Finish Size mm
18	8
20	9

Kumaş Kalınlığı
Thick Material Size

M
MH

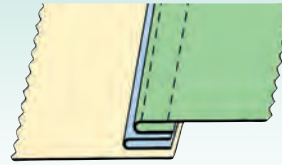

T 165A



REÇME ALTI AÇIK BİYELİ ÇATMA APERESİ

SIDE STITCHING ATTACHMENT FOR INTERLOCK MACHINES WITH BINDING ON THE BOTTOM

- Reçme etek makineleri için üretilmiştir.
- Eşortmanlar başta olmak üzere çok amaçlı kullanım alanları vardır.

- Produced for plain seaming interlock machines.
- Multi-purpose usage such as jogging suits.



Arabiye Ornament Binding

Giriş Cut Size mm	Çıkış Finish Size mm
18	7
20	8

Kumaş Kalınlığı
Thick Material Size

M
MH

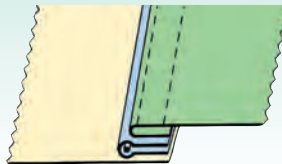

T 165B



REÇME ALTI AÇIK İPLİ ÇATMA APERESİ

SIDE STITCHING ATTACHMENT FOR INTERLOCK MACHINES WITH BINDING ON THE BOTTOM YARN

- Reçme etek makineleri için üretilmiştir.
- Eşortmanlar başta olmak üzere çok amaçlı kullanım alanları vardır.
- Altı kanaklı ayak kullanılır.

- Produced for plain seaming interlock machines.
- Multi-purpose usage such as jogging suits
- Foot with six channels is applied.



T 166

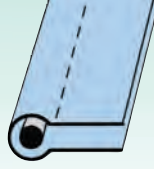

Giriş Cut Size mm	Çıkış Finish Size mm
18	8
20	9
22	10
24	11
26	12
30	14
32	15

AYAĞA İPLİ ARABIYE HAZIRLAMA APERESİ ATTACHMENT WITH FOOT, YARN, ORNAMENT BINDING FOR PREPARATION

- Düz makinalar için üretilir.
- Eşortmanlar başta olmak üzere çok amaçlı kullanım alanları vardır.
- Altı kanallı ayak kullanılır.



- Produced for lockstitch machines.
- Multi-purpose usage such as jogging suits.
- The foot can be changed.

T 167

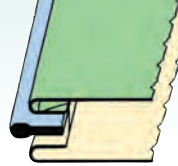
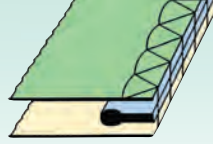

Ekstrafor Genişliği Binding Size
5
8
10
12
14
15
17
20

OVERLOK MAKİNASI FİTİLLİ EKSTRAFOR TAKMA APERESİ TAPE BINDING ATTACHMENT FOR OVERLOCK MACHINES

- Overlok makinaları için üretilir.
- Eşortman ve havlular başta olmak üzere çok amaçlı kullanım alanları vardır.
- Ayak altına kanal açılması tavsiye edilir.

- Produced for overlock machines.
- Multi-purpose usage such as jogging suits and towels.
- Making a channel under foot is recommended.



T 167A

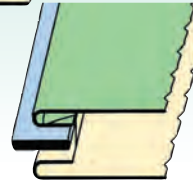
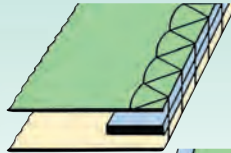
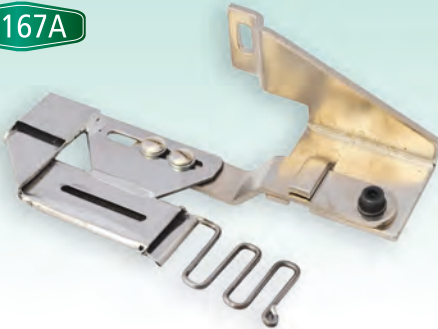

Çıkış Finish Size mm
10
12
15
20
25
30
35
40
45
50

OVERLOK EKSTRAFOR APERESİ OVERLOCK TAPE GUIDE ATTACHMENT

- Overlok makinaları için üretilmiştir.
- Eşofmanlar başta olmak üzere çok amaçlı kullanım alanları vardır.



- Produced for overlock machines.
- Multi-purpose usage especially for training wears.

Cıkış Finish Size mm	Cıkış Finish Size mm
10	10
12	12
15	15
20	20
25	25
30	30
35	35
40	40
45	45
50	50

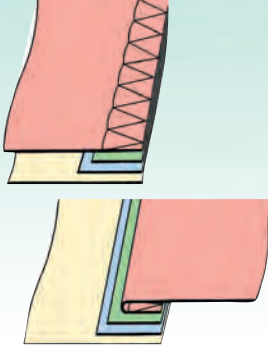

T 167B

OVERLOK ÇİFTLİ EKSTRAFÖR APERESİ OVERLOCK DOUBLE DECORATIVE RIBBON (TAPE) ATTACHMENT



- Overlok makinaları için üretilmiştir.
- Eşofmanlar başta olmak üzere çok amaçlı kullanım alanları vardır.

- Produced for overlock machines.
- Multi-purpose usage especially for training wears.

Ekstrofor Geniřlięi Binding Size
5
8
10
12
14
15
17
20

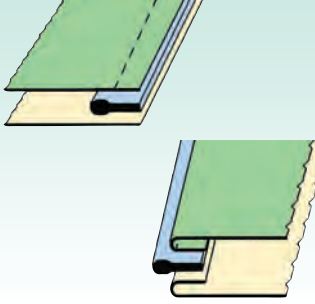

T 168

DÜZ MAKİNA FİTİLLİ EKSTRAFÖR TAKMA APERESİ TAPE BINDING ATTACHMENT FOR LOCKSTITCH MACHINES

- Düz dikiş makinaları için üretilir.
- Eşofmanlar başta olmak üzere çok amaçlı kullanım alanları vardır.
- Altı kanallı ayak kullanılması tavsiye edilir.

- Produced for lockstitch machines
- Multi-purpose usage such as jogging suits.
- Recommended to use foot with six channels.

Cıkış Finish Size mm
10
12
15
20
25
30
35
40
45
50

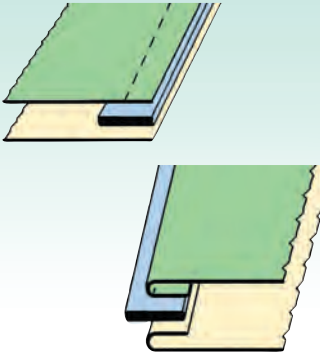

T 168A

DÜZ MAKİNA EKSTRAFÖR APERESİ LOCKSTITCH MACHINE DECORATIVE RIBBON (TAPE) ATTACHMENT

- Düz dikiş makinaları için üretilmiştir.
- Eşofmanlar başta olmak üzere çok amaçlı kullanım alanları vardır.

- Produced for lockstitch machines.
- Multi-purpose usage especially for training wears.



T 169

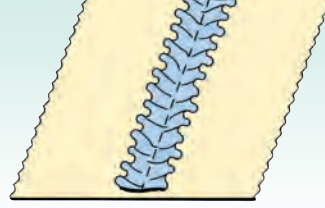
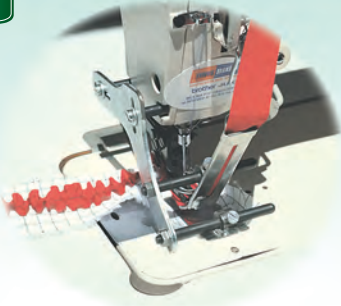

Biye Geniřliđi
Tape Size

12
15
18
20
22
25
30
35
40

ÇİFT PAPUÇ TRANSPORTLU DÜZ MAKİNA BÜZĞÜ APERESİ SMOCKING ATTACHMENT FOR LOCKSTITCH MACHINES WITH TRANSPORT



- Çift Papuç Transportlu düz dikiş makinaları için üretilir.
- Bayan tişört ve gömleklere; yaka, beden ve kol kısımlarında kullanılır.

- Produced for simple machines with transport.
- Used on the collar, body and arm parts of the lady's t-shirts and shirts.

T 169A

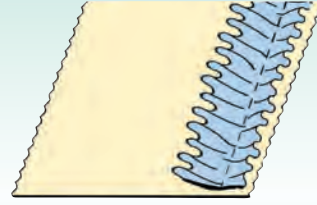

ÇİFT PAPUÇ TRANSPORTLU DÜZ MAKİNA BÜZĞÜ APERESİ SMOCKING ATTACHMENT FOR LOCKSTITCH MACHINES WITH TRANSPORT



- Çift Papuç Transportlu düz dikiş makinaları için üretilir.
- Bayan tişört ve gömleklere; yaka ve kol kısımlarında kullanılır.

- Produced for simple machines with transport.
- Used on the collar and arm parts of the lady's t-shirts and shirts.

T 169B

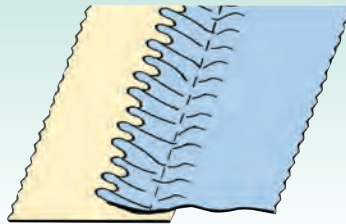

DÜZ MAKİNA ÇİNGENE ETEK APERESİ LOCKSTITCH MACHINE GYPSY TYPE SKIRT ATTACHMENT



- Düz dikiş makinaları için üretilir.
- Bayan eteklerinde kullanılır.
- Büzgü ayađı takılır.

- Produced for lockstitch sewing machines.
- Used for woman skirts.
- A special foot is mounted for smocking.

Çıkış
Finish Size
mm

Ayarlı
Adjustable

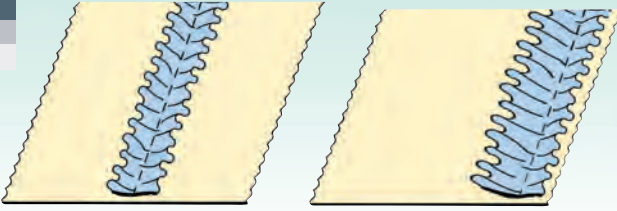

T 169C



ÇİFT PAPUÇ TRANSPORTLU DÜZ MAKİNA AYARLI BÜZGÜ APERESİ SMOCKING ATTACHMENT FOR LOCKSTITCH MACHINES WITH TRANSPORT

- Çift Papuç Transportlu düz dikiş makinaları için üretilmiştir.
- Bayan tişört ve gömlelerde; yaka beden ve kol kısımlarında kullanılır.

- Produced for double walking foot lockstitch machines.
- Used for collar, body and sleeve parts of women's t-shirts and shirts.



T 169D

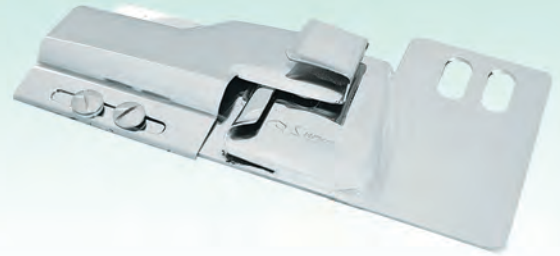
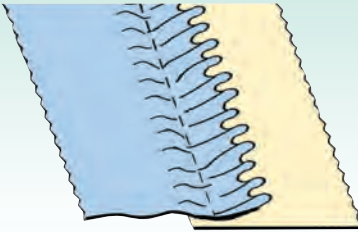

TERS BÜZGÜ APERESİ WALKING FOOT MACHINE GATHER ATTACHMENT

- Çift Papuç Transportlu düz dikiş makinaları için üretilmiştir.
- Bayan tişört ve gömlelerde; yaka beden ve kol kısımlarında kullanılır.

- Produced for double walking foot lockstitch machines.
- Used for collar, body and sleeve parts of women's t-shirts and shirts.



Giriş Cut Size mm	Çıkış Finish Size mm
25	6
30	8
35	10
40	12
45	14
50	15
50	16
55	18
60	20

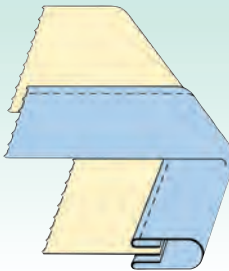

T 170



TRANSPORTLU DÜZ MAKİNA DÖRDE KATLAMA APERESİ ATTACHMENT FOR LOCKSTITCH MACHINES TO FOLD INTO FOUR

- Transportlu düz dikiş makinaları için üretilmiştir.
- Çok amaçlı kullanım alanları vardır.
- İnce kumaşlar (M) için üretilir.

- Produced for lockstitch sewing machines.
- Multi-purpose usage.
- Produced for light (M) fabrics.



T 170A

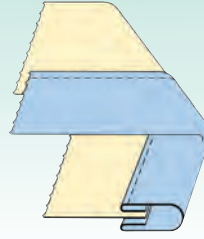
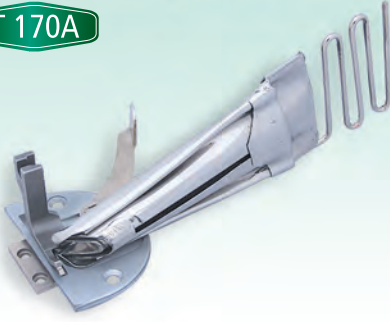

Giriş Cut Size mm	Çıkış Finish Size mm
25	6
30	8
35	10
40	12
45	14
50	15
50	16

DÜZ MAKİNA DÖRDE KATLAMA APERESİ ATTACHMENT FOR LOCKSTITCH MACHINES TO FOLD INTO FOUR



- Düz dikiş makinaları için üretilmiştir.
- Çok amaçlı kullanım alanları vardır.
- İnce kumaşlar (M) için üretilir.

- Produced for lockstitch sewing machines.
- Multi-purpose usage.
- Produced for light (M) fabrics.

T 171

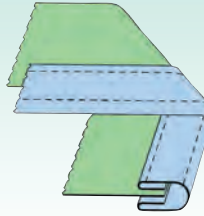

Giriş Cut Size mm	Çıkış Finish Size mm
30	8
35	10
40	10
40	12
45	14
50	15
50	16
55	18
60	20

ÇİFT İĞNE MAKİNASI DÖRDE KATLAMA APERESİ ATTACHMENT FOR DOUBLE NEEDLE MACHINES TO FOLD IN FOUR



- Çift iğne dikiş makinalarında kullanılır.
- Çok amaçlı kullanım alanları vardır.

- Used on double needle sewing machines.
- Multi-purpose usage.

T 171A

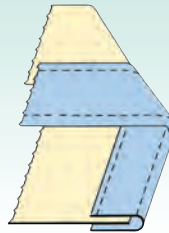

Giriş Cut Size mm	Çıkış Finish Size mm
20	10
25	12
30	15
35	17
40	20
45	22
50	25
55	27
60	30

ÇİFT İĞNE İKİYE KATLAMA BİYE APERESİ DOUBLE NEEDLE DOUBLE FOLDING BINDING ATTACHMENT



- Çift iğne dikiş makinalarında kullanılır.
- Çok amaçlı kullanım alanları vardır.

- Used on double needle sewing machines.
- Multi-purpose usage.

Arabiye Ornament Binding

Giriş Cut Size mm	Çıkış Finish Size mm
18	8
20	9

Kumaş Kalınlığı Thick Material Size

M
MH



T 172

ÇİFT İĞNE MAKİNASI ALTI AÇIK BİYELİ ÇATMA APERESİ SIDE STITCHING ATTACHMENT FOR DOUBLE NEEDLE MACHINES WITH BINDING ON THE BOTTOM

- Çift iğne dikiş makinalarında kullanılır.
- Eşortmanlar başta olmak üzere çok amaçlı kullanım alanları vardır.

- Used on double needle sewing machines.
- Multi-purpose usage such as jogging suits.



Arabiye Ornament Binding

Giriş Cut Size mm	Çıkış Finish Size mm
18	7
20	8

Kumaş Kalınlığı Thick Material Size

M
MH

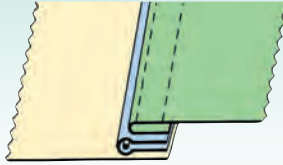

T 173

ÇİFT İĞNE MAKİNASI ALTI AÇIK İPLİ ÇATMA APERESİ SIDE STITCHING ATTACHMENT FOR DOUBLE NEEDLE MACHINES WITH BINDING ON THE BOTTOM YARN

- Çift iğne dikiş makinalarında kullanılır.
- Eşortmanlar başta olmak üzere çok amaçlı kullanım alanları vardır
- Altı kanallı ayak kullanılır..

- Used on double needle sewing machines.
- Multi-purpose usage such as jogging suits.
- Foot with six channels is applied.



T 174

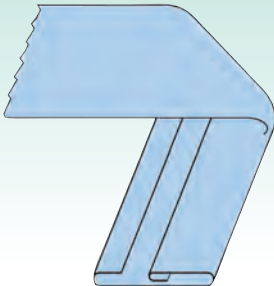

TİŞÖRT ÖN PAT PRES KIRIM APERESİ T-SHIRT FRONT PLACKET FOLDING PRES ATTACHMENT

- Press makinaları için üretilmiştir.
- Tişörtlerin ön yakalarında kullanılır.

- Produced for press machines.
- Used for front collar parts of t-shirt.





İç Çamaşırı ve Mayo Apereleri Underwear Attachments

C201

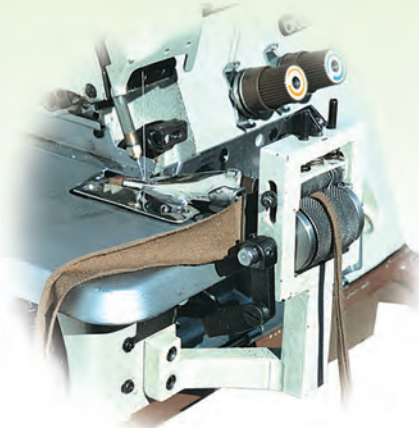
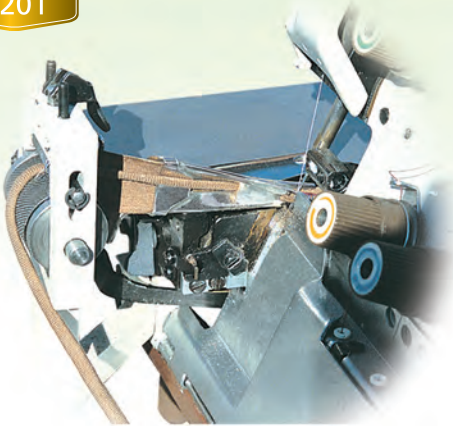

Giris Cut Size mm	Cikis Finish Size mm
14	3.5
20	5
25	7
30	8
35	10
40	12
45	14
50	16
55	18
58	20
60	22
65	25

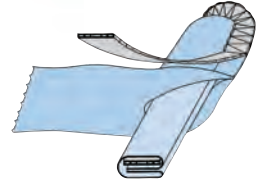
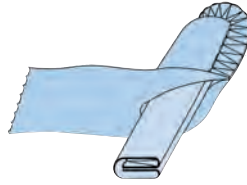
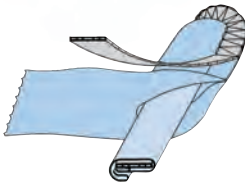

OVERLOK MAKİNASI SPAGETTİ APERESİ SPAGHETTI ATTACHMENT FOR OVERLOCK MACHINES



- Overlok Makinaları için üretilir.
- Mayolar, sütyenler, abiye kıyafetler başta olmak üzere çok amaçlı kullanım alanları vardır.
- Saten ve lıkralı kumaşlar başta olmak üzere istenilen kumaş türüne göre apare üretilir.
- Makine önüne merdane monte edilmelidir.

- Produced for overlock machines.
- Multi-purpose usage such as bathing suits, brassieres, fashion garments.
- Produced according to desired fabric types especially satin and lycra.
- A cylinder must be mounted in front of the machine.

Giriş Cut Size mm	Çıkış Finish Size mm
14	3.5
20	5
25	7
30	8
35	10
40	12
45	14
50	16

C 202

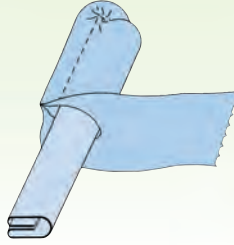

DÜZ MAKİNA SPAGETTİ APERESİ SPAGHETTI ATTACHMENT FOR LOCKSTITCH MACHINES



- Düz dikiş makinaları için üretilir.
- Mayolar, sütyenler, abiye kıyafetler başta olmak üzere çok amaçlı kullanım alanları vardır.
- Saten ve Likralı kumaşlar başta olmak üzere istenilen kumaş türüne göre apace üretilir.
- Makine önüne merdane monte edilmelidir.
- Produced for lockstitch sewing machines.
- Multi-purpose usage such as the bathing suits, brassieres, fashion garments.
- Produced according to kind of fabrics especially satin and lycra.
- A cylinder must be mounted in front of the machine

C 203

Çıkış Finish Size mm
6

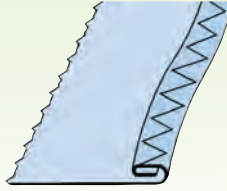

ZİGZAG MAKİNASI KIVIRMA SİPERİ FOLDING SHIELD FOR ZIG ZAG MACHINES



- Zigzag makinaları için üretilir.
- Kilotların paça ve sütyenlerin askı kısımlarında kullanılır.
- Produced for zig zag machines.
- Used on the bottom parts of the underpants and on the hanger parts of the brassieres.

C 204

Çıkış Finish Size mm
6

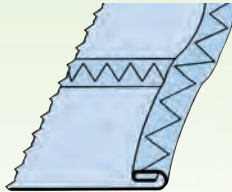

ZİGZAG MAKİNASI YAYLI SİPERİ SHIELD WITH SPRING FOR ZIG ZAG MACHINES



- Zigzag makinaları için üretilir.
- Kilotların paça ve sütyenlerin askı kısımlarında kullanılır.
- Produced for zig zag machines.
- Used on the bottom parts of the underpants and on the hanger parts of the brassieres.

C 205

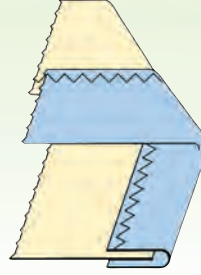

Giriş Cut Size mm	Çıkış Finish Size mm
14	7
15	7.5
16	8

ZİĞZAG MAKİNASI KATLAMA LASTİK APERESİ RUBBER FOLDING ATTACHMENT FOR ZIG ZAG MACHINES



- Zığzag makinaları için üretilir.
- Kilot paçalarında ve sütyen askılarında kullanılır.
- Dişli, plaka ve ayak değiştirilir.

- Produced for zig zag machines.
- Used on the bottom parts of the underpants and on the hanger parts of the brassieres.
- The feed dog, plate and foot can be changed.

C 206

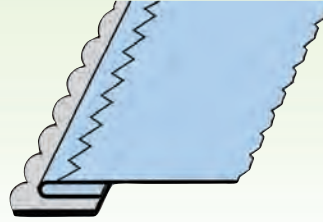

ZİĞZAG MAKİNASI BASTIRMA APERESİ HEMMER ATTACHMENT FOR ZIG ZAG MACHINES



- Zığzag makinaları için üretilir.
- Mayolarında ve iç çamaşırlarında kullanılır.

- Produced for zig zag machines.
- Used on the bathing suits and underwears.

C 207

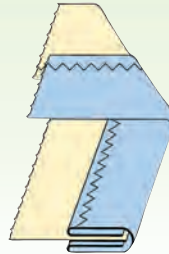
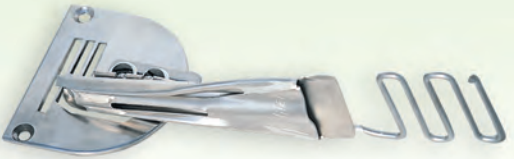

Giriş Cut Size mm	Çıkış Finish Size mm
20	5
25	6
30	7
30	8
35	10

ZİĞZAG MAKİNASI DÖRDE KATLAMA APERESİ ATTACHMENT FOR ZIG ZAG MACHINE TO FOLD IN FOUR



- Zığzag makinaları için üretilir.
- Kilotların paçalarında ve sütyenlerin askı kısımlarında kullanılır.
- Dişli, plaka ve ayak değiştirilir.

- Produced for zig zag machines.
- Used on the bottom parts of the underpants and on the hanger parts of the brassieres.
- The feed dog, plate and foot can be changed.

Giriş Cut Size mm	Çıkış Finish Size mm	Lastik Geniliği Rubber Size
20	5	4
25	6	5
30	7	6
30	8	7

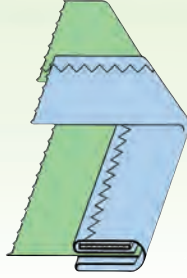

C 208



ZİGZAG LASTİKLİ DÖRDE KATLAMA APERESİ ATTACHMENT FOR ZIG ZAG MACHINE TO FOLD RUBBER INTO FOUR



- Zıgzag makinaları için üretilir.
- Kilot paçalarında ve sütyenlerin askılıklarında kullanılır.
- Dişli, plaka ve ayak değiştirilir.

- Produced for zig zag machines.
- Used on the bottom parts of the underpants and on the hanger parts of the brassieres.
- The feed dog, plate and foot can be changed.

Giriş Cut Size mm	Çıkış Finish Size mm
12	6
13	6.5
14	7
15	7.5
16	8
17	8.5
18	9
19	9.5
20	10

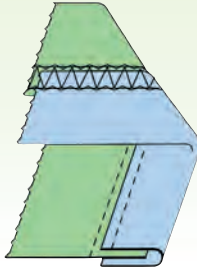

C 209



İKİYE KATLAMA REÇME LASTİK APERESİ INTERLOCK ATTACHMENT FOR DOUBLE FOLDING OF THE RUBBER



- Reçme bant makinaları için üretilmiştir.
- Mayo, sütyen ve kiltoların bel ve etek kısımlarında, bayan penyelerinin yaka kısımlarında kullanılır.

- Produced for tape binding interlock machines
- Used on the waist and bottom parts of the bathing suits, brassieres and underpants and on the collar parts of lady's t-shirts.

Giriş Cut Size mm	Çıkış Finish Size mm
15	6
18	8
22	10



C 210



ÇİFT İĞNE ORTADAN DİKİŞ AÇMA APERESİ ATTACHMENT FOR MIDDLE OPENING FOR DOUBLE NEEDLE MACHINES



- Çift iğne dikiş makinaları için üretilmiştir.
- Çift iğne dikiş makinalarının ayağına monte edilir.
- Plakaya tırnak monte edilir.

- Produced for double needle sewing machines
- It is mounted to the foot of the double needle machines
- Opener is mounted to the plate

C 211



Giriş Cut Size mm	Çıkış Finish Size mm
15	6
18	8
22	10

ÇİFT İĞNE MAKİNASI TÛLBİYE APERESİ TULLE BINDING ATTACHMENT FOR DOUBLE NEEDLE MACHINES



- Çift iğne dikiş makinaları için üretilmiştir.
- Sütyenlerde ara birleştirmede kullanılır.
- Kumaşın esnemesini önler.

- Produced for double needle machines.
- Used on the brassieres for interval connection.
- Prevents the stretch of the fabric.

C 212



Giriş Cut Size mm	Çıkış Finish Size mm
25	8
30	10

ÇİFT İĞNE MAKİNASI ŞARDON BİYE APERESİ BRUSHED BINDING ATTACHMENT FOR DOUBLE NEEDLE MACHINES



- Çift iğne dikiş makinaları için üretilmiştir.
- Sütyenlerde, mayolarda balen takmak için kullanılır.

- Produced for double needle machines.
- Used on the brassieres and bathing suits to place the whalebone.

C 213

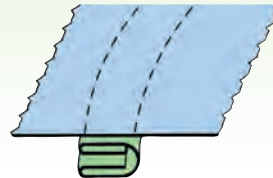

Giriş Cut Size mm	Çıkış Finish Size mm
32	8
40	10

ÇİFT İĞNE MAKİNASI BALEN APERESİ WHALEBONE ATTACHMENT FOR DOUBLE NEEDLE MACHINES



- Çift iğne dikiş makinaları için üretilmiştir.
- Sütyenlerde ve mayolarda balen takmak için kullanılır.

- Produced for double needle sewing machines.
- Used on the brassieres and bathing suits to place the ballet.

Giriş Cut Size mm	Çıkış Finish Size mm	Giriş Cut Size mm	Çıkış Finish Size mm
25	6	55	18
30	7	60	20
30	8	65	22
35	9	70	25
35	10	80	30
40	12	90	35
45	14	100	40
50	15		
50	16		

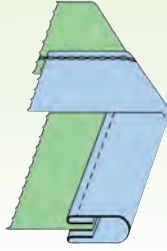

C 214

KAPALI ÇİFT KIVIRMA REÇME APERESİ INTERLOCK ATTACHMENT FOR COVERED DOUBLE FOLDING

- Reçme bant makinaları için üretilmiştir.
- Mayolar, sütyenler tişörtler, atletler ve abiye kıyafetler başta olmak üzere çok amaçlı kullanılır.
- Saten, Likralı ve benzeri kumaşlarda tercih edilir.

- Produced for tape binding interlock machines.
- Multi-purpose usage such as bathing suits, brassieres, t-shirts, top underwears, and fashion garments.
- Preferred on the satin fabrics and on the fabrics with lycra and similar fabrics.



Giriş Cut Size mm	Çıkış Finish Size mm
25	8
30	10
32	12
35	13
40	15
45	18
50	20
60	25
70	30
80	35
90	40

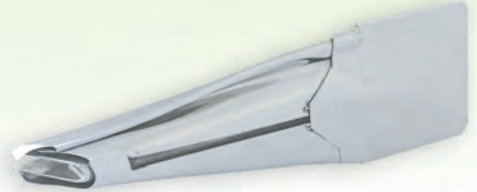
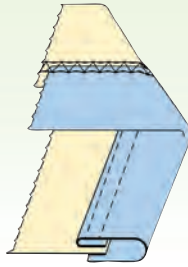

C 215

KAPALI TEK KIVIRMA REÇME APERESİ INTERLOCK ATTACHMENT FOR COVERED SINGLE FOLDING

- Reçme bant makinaları için üretilmiştir.
- Mayolar, sütyenler tişörtler, atletler ve abiye kıyafetler başta olmak üzere çok amaçlı kullanılır.
- Saten, Likralı ve benzeri kumaşlarda tercih edilir.

- Produced for tape binding interlock machines.
- Multi-purpose usage such as bathing suits, brassieres, t-shirts, top underwears, and fashion garments.
- Preferred on the satin fabrics and on the fabrics with lycra and similar fabrics.



Giriş Cut Size mm	Çıkış Finish Size mm
30	8
35	10
40	12
45	14
50	16
55	18
60	20

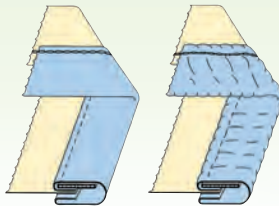

C 216

KAPALI LASTİKLİ ÇİFT KIVIRMA REÇME APERESİ TAPE INTERLOCK ATTACHMENT FOR COVERED DOUBLE FOLDING WITH RUBBER

- Reçme bant makinaları için üretilmiştir.
- Mayolar, sütyenler ve abiye kıyafetler başta olmak üzere çok amaçlı kullanılır.
- Saten, Likralı ve benzeri kumaşlarda tercih edilir.

- Produced for tape binding interlock machines.
- Multi-purpose usage such as bathing suits, brassieres and fashion garments.
- Preferred on the satin fabrics and on the fabrics with lycra and similar fabrics.



C 217

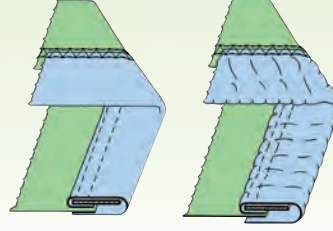
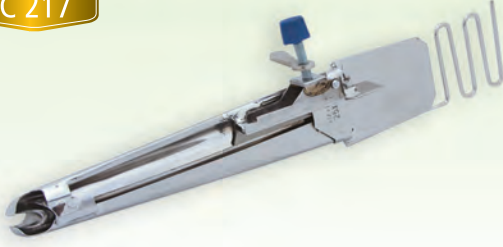

Giriş Cut Size mm	Çıkış Finish Size mm
25	8
30	10
32	12
35	13
40	15
45	18
50	20
60	25

KAPALI LASTİKLİ TEK KIVIRMA REÇME APERESİ INTERLOCK ATTACHMENT FOR COVERED SINGLE FOLDING WITH RUBBER



- Reçme bant makinaları için üretilmiştir.
- Mayolar, sütyenler ve abiye kıyafetler başta olmak üzere çok amaçlı kullanılır.
- Saten, Likralı ve benzeri kumaşlarda tercih edilir.
- Produced for tape binding interlock machines.
- Multi-purpose usage such as bathing suits, brassieres and fashion garments.
- Preferred on the satin fabrics and on the fabrics with lycra and similar fabrics.

C 218

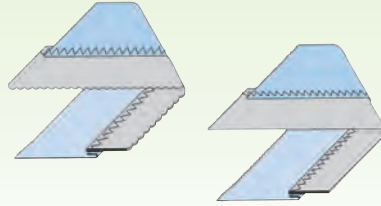

Lastik Geniřliđi Rubber Size mm
20
35
50
60
70
80
100

ZİĞZAG MAKİNASI BOYNUZLU LASTİK APERESİ HORNED RUBBER ATTACHMENT FOR ZIG ZAG MACHINES



- Pfaff zigzag makinaları için üretilir.
- Mayo ve iç çamaşırlarda paça, sütyenlerde paça ve askılık kısımlarında kullanılır.
- Procuded for Pfaff zig zag machines
- Used on the bottom parts of the bathing suits and underwears and on the uppers parts and hangers of brassieres.

C 219

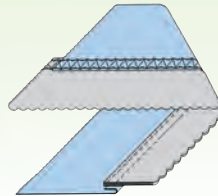

Lastik Geniřliđi Rubber Size mm
20
35
50
60
70
80
100

REÇME MAKİNASI ÜSTTEN DANTEL APERESİ UPPER LACE ATTACHMENT FOR INTERLOCK MACHINES

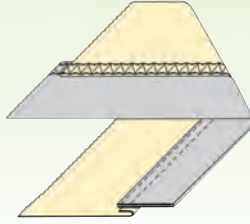

- Reçme etek makinaları için üretilmiştir.
- Bayan atletlerinde ve tişörtlerde kullanılır.
- Ayağa dantel genişliğine göre köprü monte edilir.
- Produced for plain seaming interlock machines.
- Used on the lady's top underwears and on the t-shirts.
- A metal part with channel is mounted to the foot according to the width of the lace.

Lastik Geniřliđi
Rubber Size
mm20
35
50
60
70
80
100

C 220

REÇME MAKİNASI ÜSTTEN LASTİK APERESİ UPPER RUBBER ATTACHMENT FOR INTERLOCK MACHINES

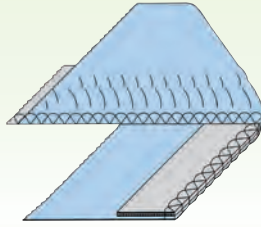

- Reçme etek makinaları için üretilir.
- Mayo ve iç çamaşırlarda paça, sütyenlerde paça ve askılık kısımlarında kullanılır.
- Ayađa lastik için tel monte edilir.
- Produced for plain seaming interlock machines.
- Used on the bottom parts of the bathing suits and the underwears, on the bottom and hanger parts of the brassieres.
- A wire is mounted to the foot for rubber.

Lastik Geniřliđi
Rubber Size
mm13
20
35
50
60
70
80
100

C 221

OVERLOK MAKİNASI ÜSTTEN LASTİK APERESİ UPPER RUBBER ATTACHMENT FOR OVERLOCK MACHINES

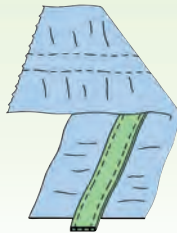

- Overlok makinaları için üretilir.
- Mayo ve iç çamaşırlarda paça, sütyenlerde paça ve askılık kısımlarında kullanılır.
- Ayađa lastik için tel monte edilir.
- Produced for overlock machines.
- Used on the bottom parts of the bathing suits and the underwears, on the bottom and hanger parts of the brassieres.
- A wire is mounted to the leg for rubber.

Lastik Geniřliđi
Rubber Size
mm4
5
6
7
8
10
12

C 222

AYAĐA LASTİK GERĐİSİ RUBBER STRETCH TO THE FOOT



- Düz diđiş makinaları için üretilmiřtir.
- Lastik gergisi ayađa monte edilir.
- Eldivenlerde, çoraplarda, bonelerde, galořlarda ve benzeri birçođ alanda kullanılır.
- Produced for lockstitch sewing machines.
- The rubber stretcher is mounted to the foot.
- Used in many areas such as gloves, socks, bonnets, galoshes and similar items.

C 223

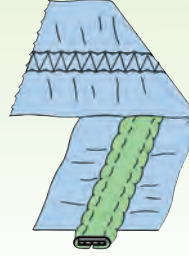

Giris Cut Size mm	Çıkış Finish Size mm	Lastik Genişliği Rubber Size mm
18	8	6
22	10	8

REÇME MAKİNASI LASTİKLİ ŞERİT APERESİ RUBBER RIBBON ATTACHMENT FOR INTERLOCK MACHINES

- Reçme etek makinaları için üretilmiştir.
- Mayo, sütyen askılıkları başta olmak üzere çok amaçlı kullanılır.

- Produced for plain seaming interlock machines.
- Multi-purpose usage such as bathing suits, brassieres' hangers.



C 224

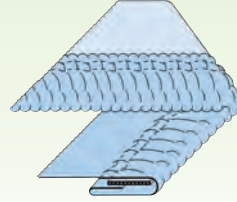
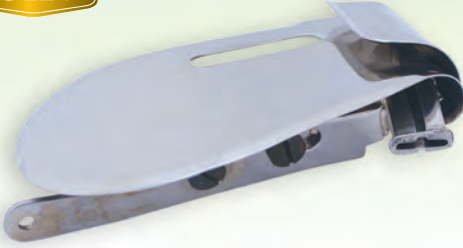

Lastik Genişliği Rubber Size mm
8
10
12
14
16
20

GİZLİ LASTİK APERESİ HIDDEN RUBBER ATTACHMENT

- Rimoldi ve Kansai Special gizli lastik Reçme makinaları için üretilir.
- Kilot ve mayolar başta olmak üzere çok amaçlı olarak kullanılır.
- Makinaların ön ve arka taraflarında merdane olması gerekmektedir.

- Produced for Rimoldi and Kansai Special hidden rubber double stitch machines.
- Multi-purpose usage such as bathing suits and underpants.
- There must be cylinders on the front and back sides of the machines.



C 225

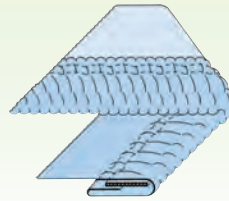

Lastik Genişliği Rubber Size mm
8
10
12
14
16
20

GİZLİ LASTİK APERESİ HIDDEN RUBBER ATTACHMENT

- Union Special ve Pegasus gizli lastik makinaları için üretilir.
- Kilot ve mayolar başta olmak üzere çok amaçlı olarak kullanılır.
- Makinaların ön ve arka taraflarında merdane olması gerekmektedir.

- Produced for Union Special and Pegasus hidden rubber machines.
- Multi-purpose usage such as bathing suits and underpants.
- There must be cylinders on the front and back sides of the machines.



C 226

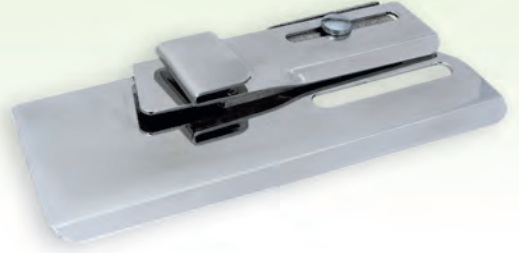

REÇME MAKİNASI KIVIRMASIZ KAFA APERESİ HEAD ATTACHMENT WITHOUT FOLDING FOR INTERLOCK MACHINES

- Reçme etek makinaları için üretilir.
- Süttyenlerde kullanılır.
- Produced for plain seaming interlock machines.
- Used on the brassieres.

C 227

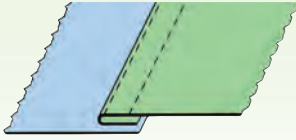

REÇME MAKİNASI KIVIRMALI KAFA APERESİ HEAD ATTACHMENT WITH FOLDING FOR DOUBLE STITCH MACHINES

- Reçme etek makinaları için üretilmiştir.
- Süttyenlerde kullanılır.
- Produced for plain seaming interlock machines.
- Used on the brassieres.

İğne Aralığı

3/16

1/8

1/4

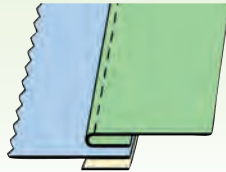

C 228

ÇİFT İĞNE KAFA APERESİ THE SUIT DOUBLE NEEDLE MACHINE ATTACHMENT

- Çift iğne dikiş makinaları için üretilir.
- Süttyenlerin kafa kısımlarında kullanılır.
- Produced for double needle machines.
- Used for head parts of brassieres.



C 229



ÇİFT İĞNE MAKİNASI BİYE ÇARDAĞI DOUBLE NEEDLE TAPE ROCK

- Çift iğne makinaları için üretilir.
- C211, C212 ve C213 nolu aperelerde kullanılır.



- Produced for double needle machines.
- Used with C221, C212 and C213 coded attachments.

C 230

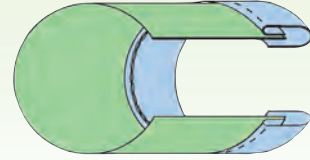

TÜP BANT APERESİ TUBE TAPE ATTACHMENT

- Burunlu reçme etek makinaları için üretilir.
- Erkek kiltolarının bel kısımlarında kullanılır.
- Hava tertibatı gerekir.



- Produced for plain seaming cylinder bed machines.
- Used on waist parts of man's underpants.
- Air system is required.

C 231

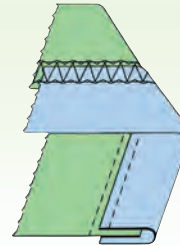

Giriş Cut Size mm	Çıkış Finish Size mm
12	6
14	7
16	8

BİÇAKLI İKİYE KATLAMA REÇME APERESİ INTERLOCK ATTACHMENT WITH KNIFE FOR FOLDING INTO TWO

- Bıçaklı reçme makinaları için üretilir.
- Bayan kiltolarının bel ve paça kısımlarında kullanılır.



- Produced for interlock machines with knife
- Used on waist and bottom parts of woman's panties.



Gömlek Apereleri Shirt Attachments

Giriş Cut Size mm	Çıkış Finish Size mm
45	22
50	25
55	28
60	30
70	35

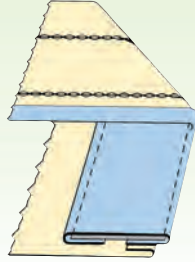

G 301

ŞERİT MAKİNASI ÜSTTEN TAKMA PAT APERESİ RIBBON MACHINE PLACKET MOUNTED FROM TOP ATTACHMENT

- Çok iğneli şerit makinaları için üretilmiştir.
- Gömleklerin ön pat kısımlarında kullanılır.



Produced for multi-needle ribbon machines.
Used for front placket of shirts.

Giriş Cut Size mm	Çıkış Finish Size mm
60	20
70	25
85	30
90	32
95	35
100	38
110	40

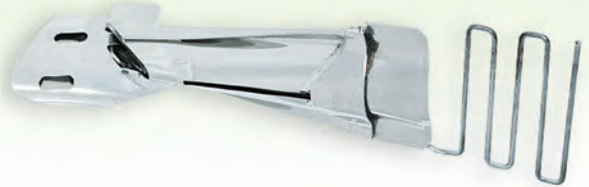
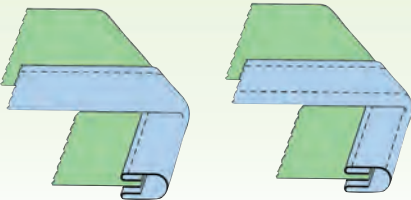

G 301A

ÇİFT İĞNE MAKİNASI ÖN PAT APERESİ DOUBLE NEEDLE MACHINES FRONT PAT ATTACHMENT

- Düz çift iğne dikiş makinaları için üretilmiştir.
- Çift iğne dikiş makinasında dişli, ayak, plaka, iğne bağı istenilen ölçüye göre değişir.
- Gömleklerin ön pat kısmında kullanılır.



- Produced for double needle sewing machines
- According to desired measurement feed dog, foot, plate, needle connections of double needle sewing machines are changed.
- This is used on the front placket of the shirts.

G 301B

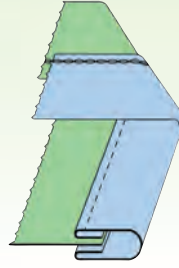
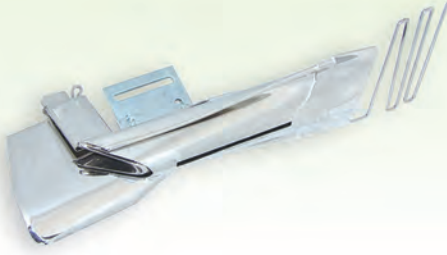

Giriş Cut Size mm	Çıkış Finish Size mm
60	20
65	22
70	25
85	30
95	35

ŞERİT MAKİNASI ÖN PAT APERESİ RIBBON MACHINE FRONT PLACKET ATTACHMENT

- Çok iğneli şerit makinaları için üretilmiştir.
- Gömleklerin ön pat kısımlarında kullanılır.



- Produced for multi-needle ribbon machines.
- Used for front placket of shirts.

G 301C

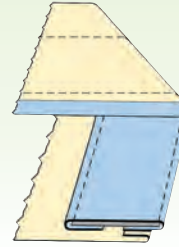

Giriş Cut Size mm	Çıkış Finish Size mm
45	22
50	25
55	28
60	30
70	35

ÇİFT İĞNE MAKİNASI ÜSTTEN TAKMA PAT APERESİ DOUBLE NEEDLE MACHINE PLACKET MOUNTED FROM TOP ATTACHMENT

- Düz çift iğne dikiş makinaları için üretilmiştir.
- Çift iğne dikiş makinasında dişli, ayak, plaka, iğne bağı istenilen ölçüye göre değişir.
- Gömleklerin ön pat kısmında kullanılır.



- Produced for double needle sewing machines
- According to desired measurement feed dog, foot, plate, needle connections of double needle sewing machines are changed.
- Used on the front placket of the shirts.

G 301D

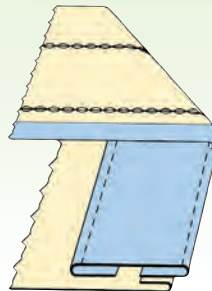

Giriş Cut Size mm	Çıkış Finish Size mm
45	22
50	25
55	28
60	30
70	35

ŞERİT MAKİNASI ÜSTTEN TAKMA PAT APERESİ RIBBON MACHINE PLACKET MOUNTED FROM TOP ATTACHMENT

- Çok iğneli şerit makinaları için üretilmiştir.
- Gömleklerin ön pat kısımlarında kullanılır.



- Produced for multi-needle ribbon machines.
- Used for front placket of shirts.

Giriş Cut Size mm	Çıkış Finish Size mm
40	20
45	22
50	25
55	28
55	30
60	30
70	35

Arabiye Ornament Binding	
Giriş Cut Size mm	Çıkış Finish Size mm
22	10
25	12

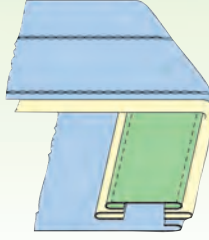

G 301E

ARABİYELİ ÜSTTEN TAKMA PAT APERESİ PLACKET MOUNTED FROM TOP WITH ORNAMENT BINDING ATTACHMENT

- Düz çift iğne dikiş makinaları ve çok iğneli şerit makinaları için üretilmiştir.
- Gömleklerin ön pat kısımlarında kullanılır.
- Produced for double needle lockstitch machines and multi-needle ribbon machines.
- Used for front placket of shirts.



Giriş Cut Size mm	Çıkış Finish Size mm
40	20
45	22
50	25
55	28
55	30
60	30
70	35

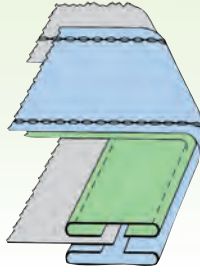

G 301F

ALT ÜST TAKMA PAT APERESİ UP AND DOWN MOUNTING PLACKET ATTACHMENT

- Düz çift iğne dikiş makinaları ve çok iğneli şerit makinaları için üretilmiştir.
- Gömleklerin ön pat kısımlarında kullanılır.
- Produced for double needle lockstitch machines and multi-needle ribbon machines.
- Used for front placket of shirts.



Giriş Cut Size mm	Çıkış Finish Size mm
40	20
45	22
50	25
55	28
55	30
60	30
70	35

Arabiye Ornament Binding	
Giriş Cut Size mm	Çıkış Finish Size mm
22	10
25	12

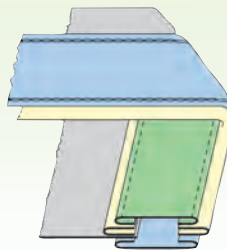

G 301G

ARABİYELİ ALT ÜST TAKMA PAT APERESİ UP AND DOWN MOUNTING PLACKET WITH ORNAMENT BINDING ATTACHMENT

- Düz çift iğne dikiş makinaları ve çok iğneli şerit makinaları için üretilmiştir.
- Gömleklerin ön pat kısımlarında kullanılır.
- Produced for double needle lockstitch machines and multi-needle ribbon machines.
- Used for front placket of shirts.



G 302

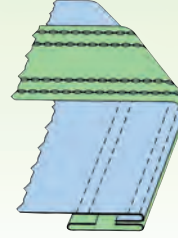

Giriş Cut Size mm	Çıkış Finish Size mm
50	30
52	32
55	35
58	38
60	40

ALT TAN TAKMA PAT APERESİ RESERVE TYPE TOP CENTER FOLDER



- Düz çift iğne dikiş makinaları ve çift zincir dikiş makinaları için üretilmiştir.
- Çift iğne dikiş makinasında dişli, ayak, plaka, iğne bağı istenilen ölçüye göre değişir.
- Gömleklerin ön pat kısmında kullanılır.
- Produced for lockstitch double needle sewing machines and double chaine sewing machines
- According to desired measurement feed dog, foot, plate, needle connections of double needle sewing machines are changed.
- Used on the front placket parts of shirts.

G 303

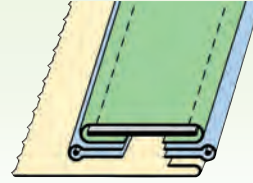
Şerit
Ribbon

Giriş Cut Size mm	Çıkış Finish Size mm
50	30
52	32
55	35
58	38
60	40

Arabiye
Ornament Binding

Giriş Cut Size mm	Çıkış Finish Size mm
24	11

BİYELİ ÜSTTEN TAKMA PAT APERESİ CORP EDGE PIPING, TOP CENTER FOLDER FROM UP SIDE



- Düz çift iğne dikiş makinaları ve çift zincir dikiş makinaları için üretilmiştir.
- Çift iğne dikiş makinasında dişli, ayak, plaka, iğne bağı istenilen ölçüye göre değişir.
- Gömleklerin ön pat kısmında kullanılır.
- Produced for lockstitch double needle sewing machines and double chaine sewing machines
- According to desired measurement feed dog, foot, plate, needle connections of double needle sewing machines are changeable.
- Used on the front placket parts of shirts.

G 304

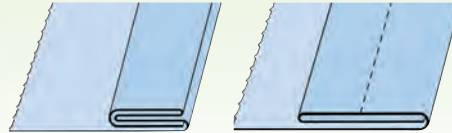

Giriş Cut Size mm	Ütü Press Size mm	Çıkış Finish Size mm
60	30	35
70	30	35

GİZLİ PAT APERESİ HIDDEN TOP CENTER FOLDER



- Düz dikiş makinaları için üretilmiştir.
- Geniş ayak kullanılır.
- Gömleklerin gizli pat kısımlarında kullanılır.
- Produced for lockstitch machines.
- Wide foot is used.
- Used on the hidden placket parts of the shirts.

G 305

Çıkış Finish Size mm
30
32
35
38
40

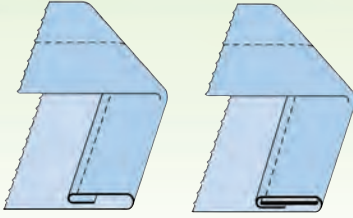

ÜSTTEN RUGANA APERESİ TOP CENTER FOLDER FROM BELOW ATTACHMENT

- Düz dikiş makinalar için üretilmiştir.
- Arkaya merdane konulması tavsiye olunur.
- Geniş ayak kullanılır.
- Gömleklerin ön patında kullanılır.

- Produced for lockstitch machines.
- Placing a roller to the rear is recommended.
- Wide foot is used.
- Used on front placket parts of the shirts

G 306

Çıkış Finish Size mm
20
22
25
28
30

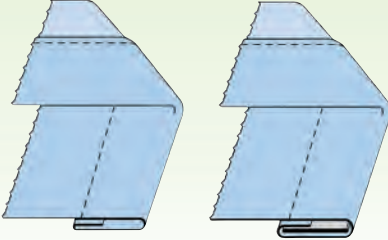

ALTTAN RUGANA APERESİ TOP CENTER FOLDER FROM UPPER SIDE ATTACHMENT

- Düz dikiş makinalar için üretilmiştir.
- Arkaya merdane konulması tavsiye edilir.
- Geniş ayak kullanılır.
- Gömleklerin ön pat kısımlarında kullanılır.

- Produced for lockstitch machines.
- Placing a roller to the rear is recommended.
- Wide foot is used.
- Used on front placket parts of the shirts

G 307

Çıkış Finish Size mm
30
32
35
38
40

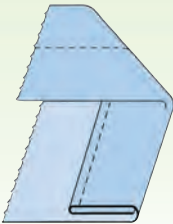

DİBE DAYAMA RUGANA APERESİ TOP CENTER FOLDER AGAINST TO THE BOTTOM ATTACHMENT

- Düz dikiş makinalar için üretilmiştir.
- Merdane kullanılması tavsiye edilir.
- Geniş ayak kullanılır.
- Gömleklerin ön pat kısımlarında kullanılır.

- Produced for lockstitch machines.
- Using a roller is recommended.
- Wide foot is used.
- Used on front placket parts of the shirts

G 308

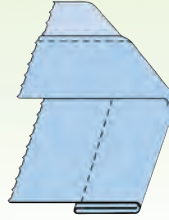

Cıkış Finish Size mm
30
32
35
38
40

DİBE DAYAMA TERS RUGANA APERESİ TOP CENTER FOLDER EDGE AGAINST TO THE BOTTOM ATTACHMENT



- Düz dikiş makinaları için üretilmiştir.
- Merdane kullanılması tavsiye edilir.
- Geniş ayak kullanılır.
- Gömleklerin ön pat kısımlarında kullanılır.

- Produced for lockstitch machines.
- Using a roller is recommended.
- Wide foot is used.
- Used on front placket parts of the shirts

G 309

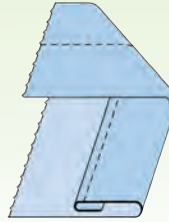

Cıkış Finish Size mm
20
22
25
28
30

DÜĞME PAT APERESİ BUTTON FOLDER ATTACHMENT



- Düz dikiş makinaları için üretilmiştir.
- Merdane kullanılması tavsiye edilir.
- Geniş ayak kullanılır.
- Gömleklerin ön pat kısımlarında ve kısa kol ağızlarında kullanılır.

- Produced for lockstitch machines.
- Using a roller is recommended.
- Wide foot is used.
- Used on front placket parts of the shirts and on the cuffs of the short sleeved skirts.

G 310

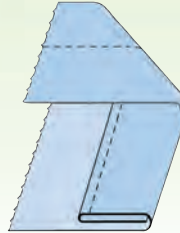

Cıkış Finish Size mm
20
22
25
28
30

DİBE DAYAMA DÜĞME PAT APERESİ BUTTON FOLDER ATTACHMENT LEANED AGAINST TO THE BOTTOM



- Düz dikiş makinaları için üretilmiştir.
- Merdane kullanılması tavsiye edilir.
- Geniş ayak kullanılır.
- Gömleklerin ön pat kısımlarında ve kısa kol ağızlarında kullanılır.

- Produced for lockstitch machines.
- Using a roller is recommended.
- Wide foot is used.
- Used on front placket parts of the shirts and on the cuffs of the short sleeved skirts.

G 311

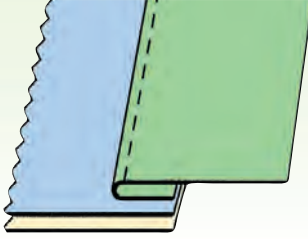

OMUZ ARKA ROBA APERESİ SHOULDER REAR YOKE ATTACHMENT

- Düz dikiş makinaları için üretilmiştir.
- Gömleklerin arka roba kısımlarında kullanılır.



- Produced for lockstitch machines.
- Used at the rear yoke side of the shirts.

G 311A

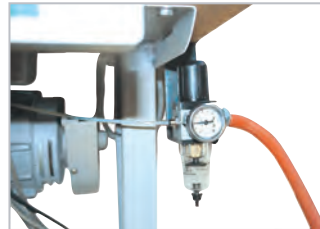
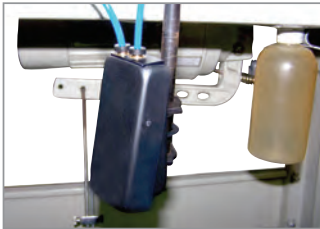
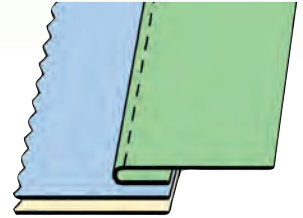

HAVALI OMUZ ARKA ROBA APERESİ PNEUMATIC SHOULDER REAR YOKE ATTACHMENT

- Düz dikiş makinaları için üretilmiştir.
- Gömleklerin arka roba kısımlarında kullanılır.
- Hava tertibatı ile çalışır.



- Produced for lockstitch machines.
- Used at the rear yoke side of the shirts.
- Works by air power system.

G 312

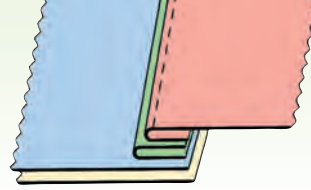

Arabiye
Ornament Binding

Giriş Cut Size mm	Çıkış Finish Size mm
20	10

BİYELİ OMUZ ARKA ROBA APERESİ SHOULDER REAR YOKE WITH BINDING RIBBON ATTACHMENT

- Düz dikiş makinaları için üretilmiştir.
- Gömleklerin arka roba kısımlarında kullanılır.

- Produced for lockstitch machines.
- Used at the rear yoke side of the shirts.

G 313

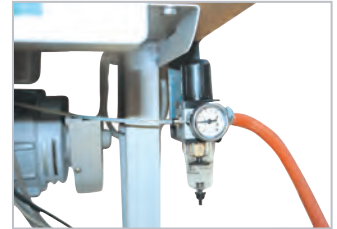
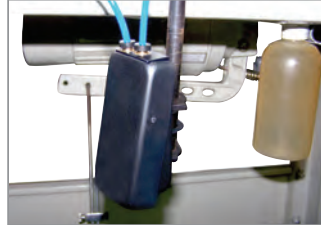
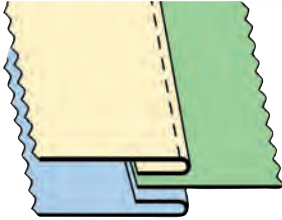

HAVALI OMUZ ALMA APERESİ PNEUMATIC SHOULDER RETAINING ATTACHMENT

- Düz dikiş makinaları ve transportlu düz dikiş makinaları için üretilmiştir.
- Düz dikiş makinaları ayak ve plaka değiştirilir.
- Hava tertibatı ile çalışır.
- Gömleklerin üst almada kullanılır.

- Produced for lockstitch machines and transport lockstitch machines.
- When used with lockstitch sewing machines, foot and plate set is changed.
- Works by air power system.
- Used to adjust upper side of the shirts.



G 314

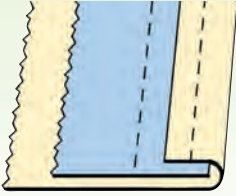

BOSS APERESİ BOSS ATTACHMENT

- Zincir dikiş (kilit dikiş) çift iğne makinaları için üretilmiştir.
- Gömleklerin kol takma (Boss) kısımlarında kullanılır.
- Apare standarttır, dikiş genişliği makinanın iğne aralıkları belirler.

- Produced for chain stitch sewing and double needle machines.
- Used on the boss side of the shirts.
- This attachment is a standard product, wideness of the sewing is regulated by the intervals of the needle.



G 315

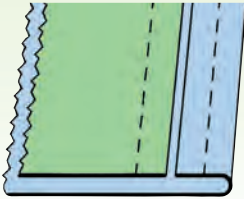

AYARLI ÇİFT DİKİŞ BOSS APERESİ ADJUSTABLE DOUBLE STITCH BOSS ATTACHMENT

- Zincir dikiş (kilit dikiş) çift iğneler için üretilmiştir.
- Gömleklerin kol takma (Boss) kısımlarında kullanılır.

- Produced for chain stitch sewing and double needle machines.
- Used on the boss side of the shirts.



G 315A

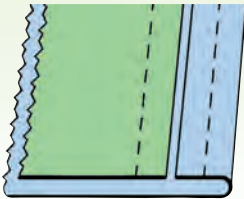

ÇİFT DİKİŞ BOSS APERESİ DOUBLE STITCH BOSS ATTACHMENT

- Zincir dikiş (kilit dikiş) çift iğneler için üretilmiştir.
- Gömleklerin kol takma (Boss) kısımlarında kullanılır.

- Produced for chain stitch sewing and double needle machines.
- Used on the boss side of the shirts.



G 317



G 316



Çıkış
Finish
Size
mm

8

10

12

BOSS APERESİ BOSS ATTACHMENT



- Düz dikiş makinaları için üretilmiştir.
- G317 Gömleklerin beden ve kol kısımlarını birleştirmek için kullanılır.
- G316 Gömleklerin kol üstü gazi dikişlerinde kullanılır.

- Produced for lockstitch machines.
- G317 Used for joining body and sleeve parts of shirts
- G316 Used on the boss side of the shirts.

G 318



DÜZ MAKİNA ETEK APERESİ HEMMER ATTACHMENT FOR FLAT SEWING MACHINE

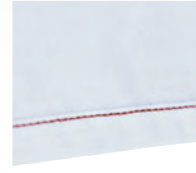
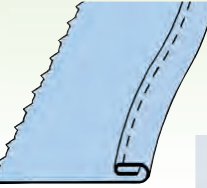

- Düz dikiş makinaları için üretilir.
- Gömleklerin etek kısımlarında kullanılır.
- Ayak değiştirilir.

- Produced for lockstitch machines.
- Used for bottom edges of shirts.
- Presser foot changeable.

Çıkış
Finish
Size
mm

3

4

5

6

G 320



PFSAFF ETEK APERESİ PFSAFF SKIRT ATTACHMENT

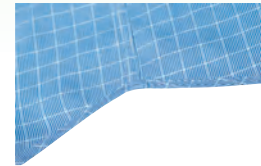
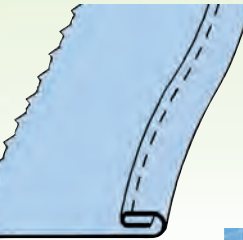

- Pfaff düz dikiş makinalarında üretilir.
- Gömleklerin etek kısımlarında kullanılır.

- Produced for Pfaff lockstitch machines.
- Used on bottom edges of shirts.

Çıkış
Finish
Size
mm

4

5

6

G 321

Çıkış
Finish
Size
mm

4
5
6

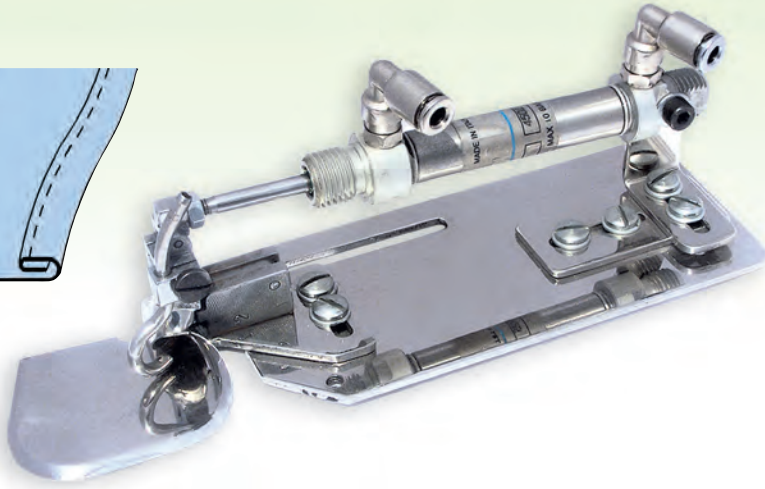
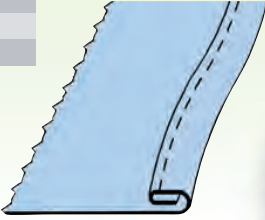

TRANSPORTLU DÜZ MAKİNA HAVALI ETEK APERESİ LOCKSTITCH MACHINE WITH TRANSPORT PNEUMATIC ATTACHMENT



- Transportlu düz dikiş makinaları için üretilir.
- Gömleklerin etek kısımlarında kullanılır.
- Hava tertibatı gerekir.

- Produced for walking foot lockstitch machines.
- Used on bottom edges of shirts.
- Works by air power system

G 321A

Çıkış
Finish
Size
mm

4
5
6
7
8

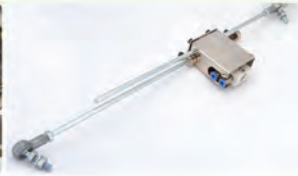
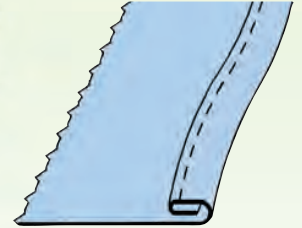

İĞNE TRANSPORTLU HAVALI ETEK APERESİ PNEUMATIC HEMMING ATTACHMENT



- Düz dikiş makinaları, iğneli transportlu düz dikiş makinaları ve ayak transportlu dikiş makinaları için üretilmiştir.
- Gömleklerin etek kısımlarında kullanılır.
- Hava tertibatı gerekir.
- Düz dikiş makinaları ve iğne transportlu düz dikiş makinalarında ayak değişir.
- Ayak transportlu düz dikiş makinalarında dişli, plaka ve ayak değişir.

- Produced for lockstitch machines, needle feed lockstitch machines and walking foot sewing machines.
- Used for bottom edges of shirts.
- Air system is needed.
- Foot is changed with lockstitch and needle feed lockstitch machines.
- Needle plate, feed dog and foot set is changed with walking foot lockstitch sewing machines.

G 322

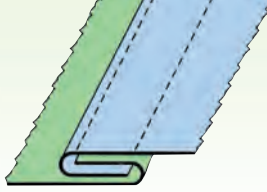

Kumaş Kalınlığı Thick Material Size
MH

İğne Aralığı Needle Size inc
3/16
1/4

GÖMLEK KOLLU APERESİ ARM SEWING MACHINE SHIRT ATTACHMENT

- Zincir dikiş çift iğne kollu makinaları için üretilir.
- Gömleklerin beden çatımlarında kullanılır.



- Produced for double needle chain stitch arm sewing machines.
- Used for folding body parts of shirts.

G 323



GÖMLEK YAKASINDA İLİK HİZALAMA APERESİ SHIRT COLLAR BUTTON HOLES ALIGNMENT ATTACHMENT

- İlik düğme makinaları için üretilir.
- Gömlek yakalarında kullanılır.



- Produced buttonhole / buton sewing machines.
- Used on collars of shirts.

G 324

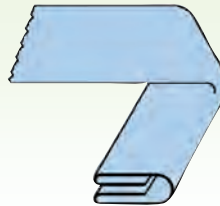

Giriş Cut Size mm	Çıktı Finish Size mm
30	8
40	10
45	12
50	15

GÖMLEK APARTULA APERESİ SHIRT SLEEVE VENT ATTACHMENT

- Pres ütü makinaları için üretilir.
- Gömleklerin kollarına biye çekmede kullanılır.



- Produced for press machines.
- Used for forming bindings on the sleeves of shirts.

Giriş Cut Size mm	Çıkış Finish Size mm
60	20
70	25

G 324A

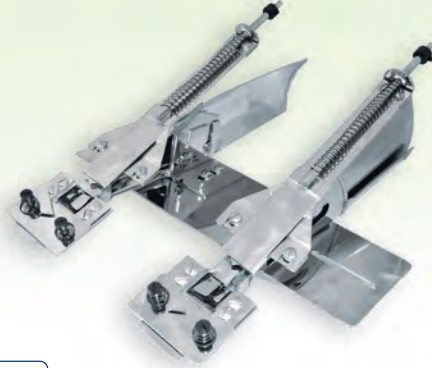

PRES APARTULA APERESİ PRES SLEEVE PLACKET ATTACHMENT



- Press ütü makinaları için üretilmiştir.
- Gömleklerin kollarına biye çekmede kullanılır.

Produced for press ironing machines.
Used for produce bindings on sleeves of shirts.

G 325

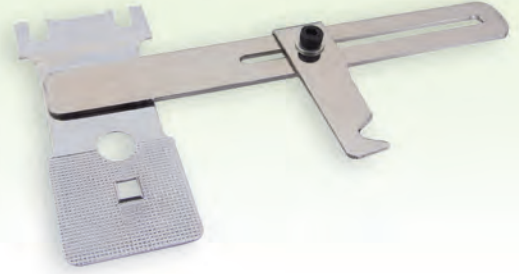
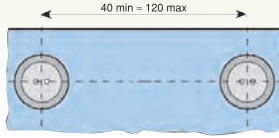

GÖMLEK DÜĞME MESAFE ÖLÇÜM APERESİ SHIRT BUTTON INTERVALS MEASURING ATTACHMENT



- Düğme dikme makineleri için üretilir.
- Düğme mesafe aralıklarını ayarlama için kullanılır.

Produced for button sewing machines.
Used for adjusting distances between buttons.

G 326

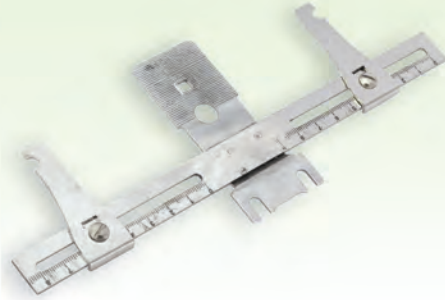
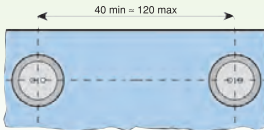

GÖMLEK ÇİFTLİ DÜĞME MESAFE ÖLÇÜM APERESİ SHIRT DOUBLE BUTTON DISTANCE MEASUREMENT ATTACHMENT



- Düğme dikme makineleri için üretilmiştir.
- Düğme mesafe aralıklarını ayarlama için kullanılır.

Produced for button sewing machines.
Used for adjusting distances between buttons.

G 327

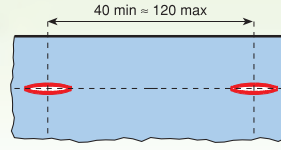
Çıkış
Finish Size
mmAyarlı
Adjustable

İLİK HİZALAMA APERESİ BUTTON HOLE ADJUSTING ATTACHMENT

- İlik açma makineleri için üretilmiştir.
- İlik mesafe aralıklarını ayarlama için kullanılır.

- Produced for button hole making machines.
- Used for adjusting distances between button holes.



G 328

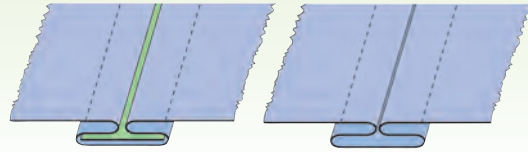

İğne Aralığı

1/2

3/4

ÇİFT İĞNE ARKA PİLE APERESİ DOUBLE NEEDLE BACK PLEAT ATTACHMENT

- Düz çift iğne dikiş makineleri için üretilmiştir
- Gömleklerin cep ve arka sırt kısımlarında kullanılır

- Produced for double needle lockstitch machines.
- Used for pocket and back parts of the shirts.

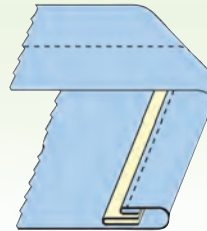

G 329

Arabiyeli
Ornament Binding

Çıkış Finish Size mm	Giriş Cut Size mm	Çıkış Finish Size mm
20		
25		
30	22	10
35		
40		
45		
50		
60		
70		
80	25	12
90		
100		

ARABİYELİ DÜĞME PAT APERESİ BUTTON PLACKET WITH ORNAMENT BINDING ATTACHMENT

- Düz çift iğne dikiş makineleri için üretilmiştir
- Gömleklerin ön pat kısımlarında ve kol ağzlarında kullanılır.

- Produced for double needle lockstitch machines.
- Used for front plackets and cuffs of shirts (bottom of sleeves).

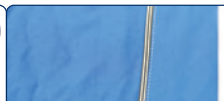



Special Apereler Related Special Attachments

Ağız Genişliği Mouth Wideness mm	Giriş Cut Size mm	Çıkış Finish Size mm
3.5	12	6
4	14	7
4.5	16	8
5	18	9
5.5	20	10
6	22	11
6.5	25	12
7	28	14
7.5	30	15
8	32	16
	35	17
	38	19
	40	20
	45	22

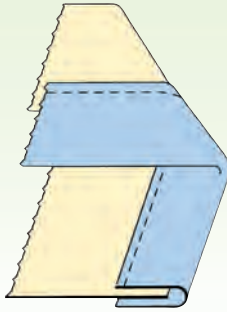

Y 401

SAYA APERESİ RIGHT ANGLE BINDER

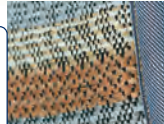

- Çift Papuç saya makineleri için üretilmiştir. *Produced for double cylinder bed lockstitch machines.*
- Genellikle halılar, paspaslar, çantalar, cüzdanlar, cep telefonları kılıfları, ayakkabı ve terlikler başta olmakla birlikte birçok kullanım alanları vardır. *Generally, used to manufacture, rugs, doormats, bags, wallets, case of GSM telephone sets, shoes and slippers and more over there are several space of usage.*
- Her türlü deri, dokuma kumaş ve benzeri kumaşlar için üretilmiştir. *Produced to manufacture every kinds of leathers, woven fabrics and similar kinds of materials.*

Ağız Genişliği Mouth Wideness mm	Giriş Cut Size mm	Çıkış Finish Size mm
7	25	12
7.5	30	15
8	35	17
8.5	40	20
9	42	21

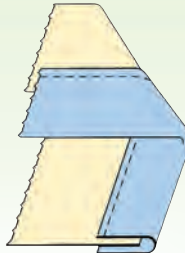

Y 401A

SİPERLİ SAYA APERESİ RIGHT ANGLE BINDER WITH GUARD PLATE



- Çift Papuç saya makineleri için üretilmiştir. *Produced for double feet cylinder bed lockstitch.*
- Halılar ve yatak kenarlarına biye çekmede kullanılır. *Used for forming bindings on the edges of carpets and mattresses.*
- Dokuma ve benzeri kumaşlar için üretilir. *Used with woven and similar fabrics.*

Y 402

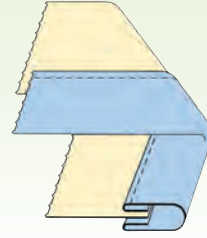
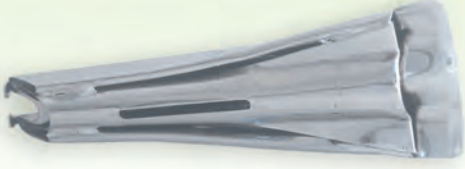

Giriş Cut Size mm	Çıkış Finish Size mm
35	8
40	10
45	12
50	14

YORGAN APERESİ QUILT ATTACHMENT

- Çift Papuç saya makinaları için üretilmiştir.
- Yorganlarda, havlu ve terlik kenarlarında kullanılır.
- Saten, ince kaygan kumaşlar için üretilir.



- Produced for double feet cylinder bed lockstitch machines
- Used on quilts and on the edges of towels and slippers.
- Produced for saten, thin slippery fabrics.

Y 402A

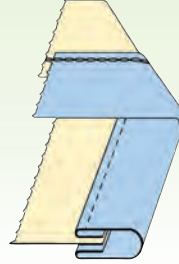
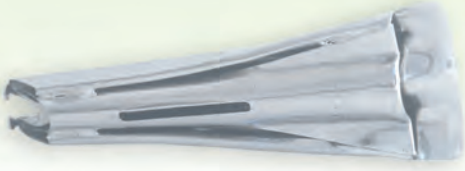

Giriş Cut Size mm	Çıkış Finish Size mm
35	8
40	10
45	12
50	14

BIÇAKLI YORGAN APERESİ QUILT ATTACHMENT WITH KNIFE

- Bıçaklı yorgan makinaları için üretilmiştir.
- Yorgan ve havlu kenarlarında kullanılır.
- Saten, ince kaygan kumaşlar için üretilir.

- Produced for quilt machines with knife
- Used on the edges of quilts and towels
- Produced for saten, thin slippery fabrics.

Y 403

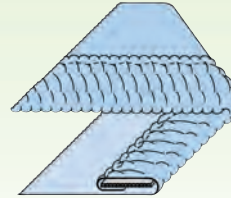

Lastik Geniřliđi Rubber Size mm
8
10
12
15

LASTİKLİ ÇARŞAF KENARI APERESİ SHEET EDGE ATTACHMENT WITH RUBBER BAND

- İğne transportlu düz dikiş makinaları için üretilmiştir.
- Çarşaf, branda kenarları, yağmurlukların kol ve etek kısımlarında kullanılır.



- Produced for lockstitch machines with needle transported.
- Used to align sleeve and edge of raincoats and edges of sailor 's hammock (canvas).

Giriş Cut Size mm	Çıkış Finish Size mm
70	25
85	30
95	35
100	38
110	40
125	50

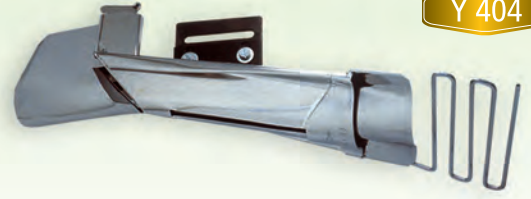
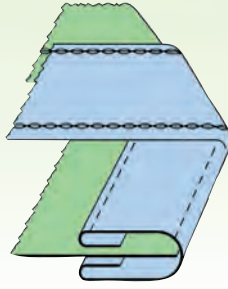

Y 404

ÇOK AMAÇLI YATAK ÖRTÜ APERESİ MULTI-PURPOSE BED CLOTHES ATTACHMENT

- 4 iğne kemer makinası ve 4 iğne lastik makinaları için üretilmiştir.
- Yatak örtüsü ve perde kenarlarında kullanılır.

- Produced for 4 needles belt machines and for 4 needles rubber machines.
- Used on bed clothes and edges of curtains.



Giriş Cut Size mm	Çıkış Finish Size mm	Arabeye Ornament Binding	
70	25		
85	30	22	10
95	35		
100	38	25	12
110	40		
125	50		

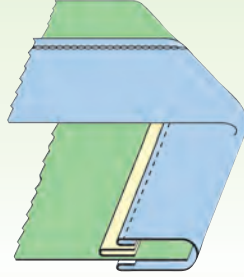

Y 404A

ARABİYELİ ÇOK AMAÇLI YATAK ÖRTÜ APERESİ MULTI-PURPOSE BED COVER WITH ORNAMENT BINDING ATTACHMENT

- 4 iğneli kemer makinaları ve çok iğneli şerit makinaları için üretilmiştir.
- Yatak örtüsü ve perde kenarlarında kullanılır.

- Produced for 4 needles waistband machines and multi-needle ribbon machines.
- Used for bed covers and curtain edges.



Fermuar Genişliği Zipper wideness mm
2.5
3
3.5

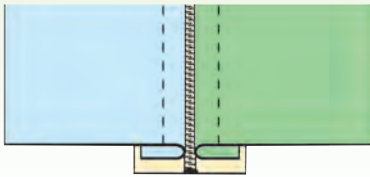

Y 405

FERMUAR APERESİ ZIPPER ATTACHMENT

- Şerit makinaları için üretilir.
- Yatak örtülerinde, kılıflarda ve çantalarda kullanılır.

- Produced for ribbon machines.
- Used with bedclothes, pillow cases and bags.



Y 406



Fermuar Geniřliđi Zipper wideness mm	Apere Cıkıřı Final size mm
2.5	20
3	25
3.5	30
	35

DÜZ MAKİNA FERMUAR APERESİ LOCKSTITCH MACHINE ZIPPER ATTACHMENT

- Düz dikiş makinaları için üretilir.
- Yatak örtülerinde kullanılır.



- Produced for lockstitch sewing machines.
- Used with bedclothes.

Y 407

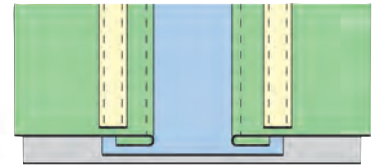
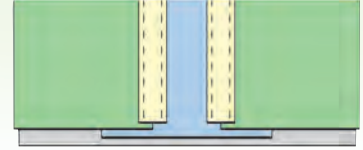

YATAK KENAR APERESİ MATTRESS EDGE ATTACHMENT

- Çok iğneli şerit makinaları için üretilmiştir.
- Yatak kenarlarını dikmede kullanılır.
- Apere istenilen ölçülerde yapılır. (İğne aralığı önemlidir)



- Produced for multi-needle ribbon machines.
- Used for sewing edges of mattresses.
- Produced for all sizes ordered.

Giriş Cut Size mm	Çıkış Finish Size mm
80	50

Sünger Sponge mm
50

Y408

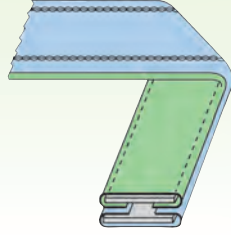

YATAK KULP APERESİ MATTRESS HANDLE ATTACHMENT

- 4 iğneli kemer makinaları ve çok iğneli şerit makinaları için üretilmiştir.
- Yatak kulplarını dikmede kullanılır.

- Produced for 4 needles waistband machines and multi-needle ribbon machines.
- Used for sewing handles of mattresses.

Çıkış Finish Size mm
6
8

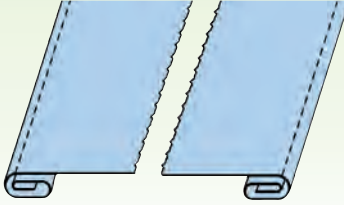

H 501



HAVLU BOY APERESİ TOWEL SIDE ATTACHMENT

- Havlu boy makinaları için üretilmiştir.
- Havlu kenarlarında kullanılır.

- Produced for towel hemming machines.
- Used to fold edges of towels.

Giriş Cut Size mm	Çıkış Finish Size mm
90	30
100	35
110	38
120	40
140	50
150	60

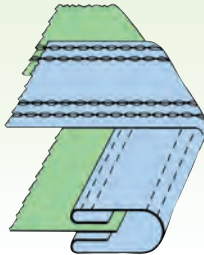

H 502



BORNOZ PERVAZ APERESİ BATH SUIT FOLDER ATTACHMENT

- 4 iğne kemer makinaları ve çift zincir dikiş şerit makinaları için üretilmiştir.
- Bornozlarda kullanılır.

- Produced for 4 needles belt machines and ribbon machines with double chain stitch.
- Used for bathrobes.

H 502A

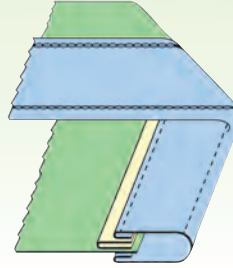

Giriş Cut Size mm	Çıkış Finish Size mm	Arabiye Ornament Binding	
		Giriş Cut Size mm	Çıkış Finish Size mm
90	30	22	10
100	35		
110	38		
120	40	25	12
140	50		
150	60		

ARABİYELİ BORNOZ PERVAZ APERESİ BATHROBE PLACKET WITH ORNAMENT BINDING ATTACHMENT

- 4 iğneli kemer makineleri ve çok iğneli şerit makineleri için üretilmiştir.
- Bornozlarda kullanılır.

- Produced for 4 needles waistband machines and multi-needle ribbon machines.
- Used for bathrobes.



H 503

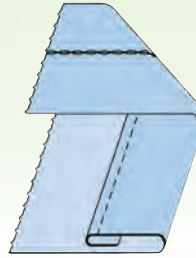

Çıkış Finish Size mm
10
15
20
25
30

BORNOZ ETEK KIVIRMA APERESİ BATH ROBE FOLDING ATTACHMENTS

- Çok iğneli şerit makineleri makineleri için üretilir.
- Bornozların etek kısımlarında kullanılır.



- Produced for ribbon machines and sewing machines.
- Used on edges of the bath suits.

H 503A

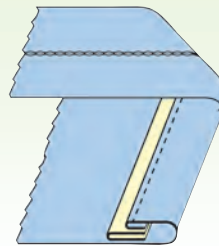

Çıkış Finish Size mm	Arabiye Ornament Binding	
	Giriş Cut Size mm	Çıkış Finish Size mm
20	22	10
25		
30		
35		
40		
45	25	12
50		
60		
70		
80		
90		
100		

ARABİYELİ BORNOZ ETEK KIVIRMA APERESİ BATHROBE EDGE WITH ORNAMENT BINDING ATTACHMENT

- Düz dikiş makineleri ve çok iğneli şerit makineleri için üretilmiştir.
- Bornozların ön pat, cep ve etek kısımlarında kullanılır.

- Produced for ribbon machines and sewing machines.
- Used for placket, pocket and edges of bathrobes.



N 601

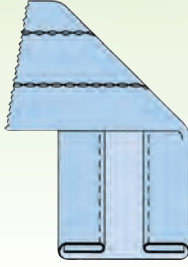

PERDE ASKI APERESİ CURTAIN HANGER ATTACHMENT



- Çift zincir dikiş makinaları için üretilmiştir.
- Tül perdelerin kuşak askı kısımlarında kullanılır.
- Apare çıkışı makinanın iğne aralığına göre ayarlanır.

- Produced for double chain sewing machines.
- Used on the band of hanger of tulle curtains.
- The outlet of attachment can be adjusted according to intervals of the needles.

Çıkış
Finish
Size
mm

20

25

30

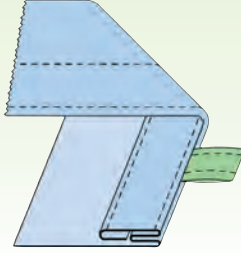

N 602

PERDE ASKI APERESİ CURTAIN HANGER ATTACHMENT



- Çift iğne dikiş makinaları için üretilmiştir.
- Tül perdelerin kuşak askı kısımlarında kullanılır.
- Çift iğne dikiş makinasında dişli, ayak, plaka ve iğne bağı istenilen ölçüye göre değiştirilir.

- Produced for double needed sewing machines.
- Used on the band of hanger of tulle curtains.
- According to desired sizes; feed dog, feet, plate and needle bar of double needed sewing machines are changeable

Çıkış
Finish
Size
mm

8

10

12

15

20

22

25

30

35

40

45

Çıkış
Finish
Size
mm

50

55

60

65

70

75

80

85

90

100

110

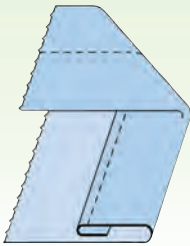

N 603

DÜZ MAKİNA ETEK APERESİ LOCK STITCH MACHINE HEMMER ATTACHMENT



- Düz dikiş makinaları ve çift zincir dikiş makinaları için üretilmiştir.
- Başta çarşaf, tül ve kumaş perde kenarları, gömlekler, masa örtüleri ve daha birçok yerde kullanılır.
- İnce kumaşlar için üretilmiştir.

- Produced for lock stitch sewing machines and double chain sewing machines.
- Primarily used for sheets, edges of tulle curtains, tableclothes, shirts and for several other things.
- Produced for thin fabrics.

N 604

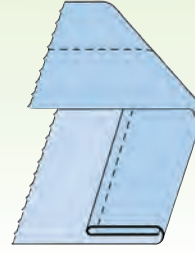
Çıkış
Finish
Size
mm

8
10
12
15
20
22
25
30
35
40

DÜZ MAKİNA DİBE DAYAMA ETEK APERESİ HEMMER ATTACHMENT FOR LOCKSTITCH MACHINE LEANED AGAINST TO THE BOTTOM



- Düz dikiş makinaları için üretilmiştir.
- Başta çarşaf, tül perde kenarları, gömlekler ve daha birçok yerde kullanılır.
- İnce kumaşlar için üretilmiştir.

- Produced for lockstitch sewing machines.
- Primarily used for sheets, edges of tulle curtains, shirts and for several other things.
- Produced for thin fabrics.

N 605

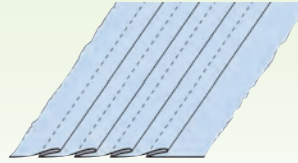

DÜZ MAKİNA NERVÜL APERESİ LOCKSTITCH MACHINE RIBS ATTACHMENT



- Düz dikiş makinaları için üretilmiştir.
- Perde, nevresim ve bayan gömleklerinde kullanılır.
- Nervül ölçüsü ve mesafesi ayarlanabilir.

- Produced for lockstitch machines
- Used with curtains, quilt covers and woman shirts.
- Dimension and distance of ribs can be adjusted

N 606

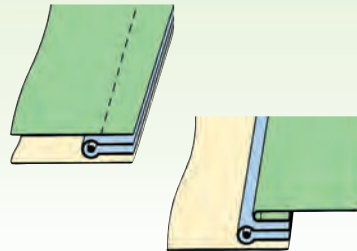
Giriş
Cut
Size
mmÇıkış
Finish
Size
mm

20	10
25	12
30	15

DÜZ MAKİNA İPLİ ARABIYE APERESİ LOCKSTITCH MACHINE ATTACHMENT FOR ORNAMENT BINDING WITH YARN



- Düz Dikiş makinaları için üretilir.
- Nevresim ve yastıklarda kullanılır.
- Altı kanallı ayak kullanılır.

- Produced for lockstitch machines
- Used with quilt covers and pillows.
- Used a foot with six channels.

S 701

Çıkış
Finish
Size
mm

3

4

5

6

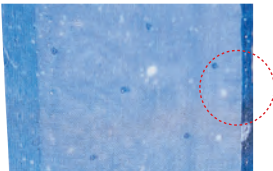
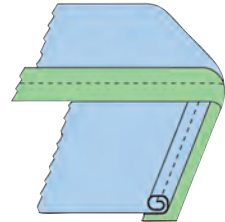
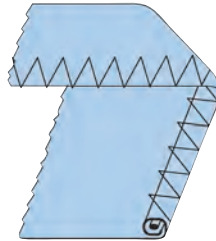
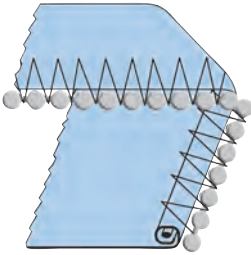

EŞARP KENAR KIVIRMA APERESİ ATTACHMENT FOR CURLING OF EDGES OF SCARFS



- Düz dikiş makinaları ve transportlu dikiş makinaları için üretilmiştir. • Produced for lockstitch machines and lockstitch machines with transportation mechanism.
- Eşarp, tül ve gelinliklerde kullanılır. • Used for tulle, scarf and bridals.
- Makina ayağı değiştirilir. • Presser foot of the machine is changeable.

S 702

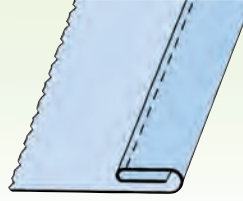
Çıkış
Finish
Size
mm

10

15

20

ÇUVAL APERESİ SACK ATTACHMENT

- Çuval makinaları için üretilmiştir.
- Çuvalarda kullanılır.



- Produced for sack machines.
- Used for sacks.

S 702A

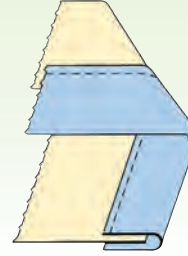

Giriş Cut Size mm	Çıkış Finish Size mm
60	30
70	35
80	40

ÇUVAL AĞZI BİYE APERESİ SACK MOUTH BINDING ATTACHMENT

- Çuval makinaları için üretilmiştir.
- Çuvalların ağızlarını kapamada kullanılır.



- Produced for sack machines.
- Used for closing mouths of sacks.

S 703

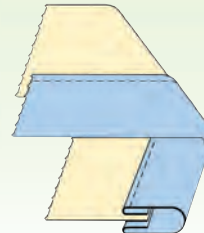

Giriş Cut Size mm	Çıkış Finish Size mm
25	7
30	8
35	10
40	11

ELYAF ÇANTA APERESİ FIBER BAGS ATTACHMENT

- Çift pabuç transportlu makinalar için üretilir.
- Reklam çantaları, elbise kılıflarında kullanılır.



- Produced for Unison-feed lockstich machines.
- Used for fiber bags and clothe cases.

Giriş Cut Size mm	Çıkış Finish Size mm
40	10
45	12
50	15
60	20
70	25

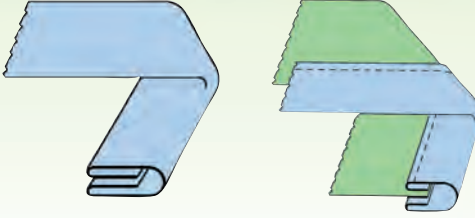

S 704

ÇOK AMAÇLI DÖRTE KATLAMA APERESİ MULTI PURPOSE FOLDING INTO FOUR ATTACHMENT



- Düz dikiş ve press ütü makinaları için üretilir.
- Çok amaçlı kullanım alanları vardır.
- Produced for lockstitch machines and press irons
- Multi-purpose usage.

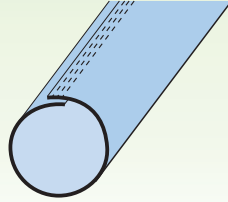

S 705

KORSE APERESİ CORSET ATTACHMENT



- Brother ve Juki üç iğne kollu makinaları için üretilir.
- Korselerin çatımında kullanılır.
- Produced for Brother and Juki three needles machines with arm.
- Used for joining parts of corsets

	Poşet Ebatları Nylon bag sizes cm	
Minimum	3	5
Maximum	13	18

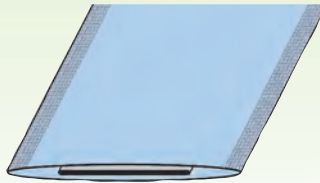

S 706

POŞET DOLUM APARESİ NYLON BAG FILLING ATTACHMENT

- Granül poşet dolum makinaları için üretilmiştir.
- Kahve, şeker, tuz, biber, çay, baharat ve benzeri malzeme dolum işlerinde kullanılır.
- Produced for granule nylon bag filling machines.
- Used for filling coffee, sugar, salt, black pepper and spices etc.

S 707

Lastik Geniřliđi Rubber Size mm
6
7
8
9
10
12
15



T 158A



T 158

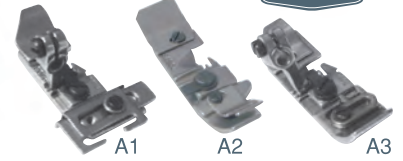

T 158B



T 158C

Lastik Geniřliđi Rubber Size mm
13
23
38
50

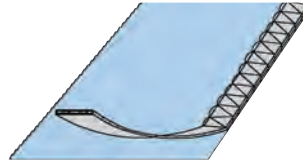

T 158D

OVERLOK MAKİNASI EKSTRAFÖR APERESİ TAPE BINDING ATTACHMENT FOR OVERLOCK MACHINES



- Overlok makinası için üretilir.
- Penye ve tiřörtlerin omuz kısımlarında kullanılır.
- Overlok makinasının ayađına ekstrafor geniřliđinde kanal açılıp, köprü yapılır.

- Produced for overlock machines.
- Used on the shoulder parts of the t-shirts and combed items.
- A channel with the same width of the band is opened on the foot of the overlock machine and then a metal part is mounted.

S 708

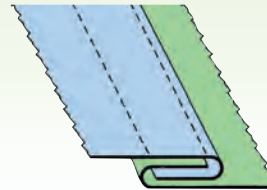

İğne Aralıđı Range of Needle
3/16
1/4
3/8
1/2

TERS ÇİFT İĞNE ÇATMA APERESİ REVERSE DOUBLE NEEDLE BINDING ATTACHMENT



- Çift iğne dikiř makineleri için üretilmiřtir.
- Bayrak, çadır ve branda çatımında kullanılır.

- Produced for double needle sewing machines.
- Used for binding parts of flags, tents and canvases.

İğne Aralığı
Range of
Needle

3/8
1/2
3/4

S 709

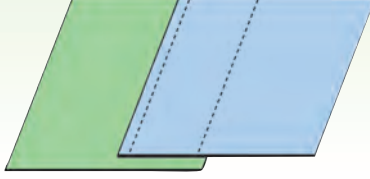

ÇADIR BRANDA ÇATIM APERESİ TENT-CANVAS BINDING ATTACHMENT



- Çift iğne dikiş makinaları için üretilmiştir.
- Çadır ve branda çatımında kullanılır.

- Produced for double needle sewing machines.
- Used for binding parts of tents and canvases.

Çıkış
Finish Size
mm

20
25
30
35

S 710

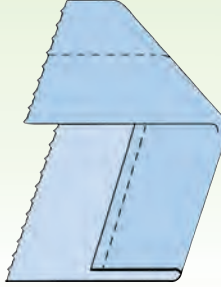

BRANDA KATLAMA APERESİ CANVAS FOLDING ATTACHMENT



- Çift iğne dikiş makinaları ve çok iğneli şerit makinaları için üretilmiştir.
- Çadır ve branda kenarlarında kullanılır.

- Produced for double needle sewing machines and multi-needle ribbon machines.
- Used for edges of tents and canvases.

Giriş
Cut
Size
mm

45 15
50 18
55 20
65 25
75 30
85 35

S 711

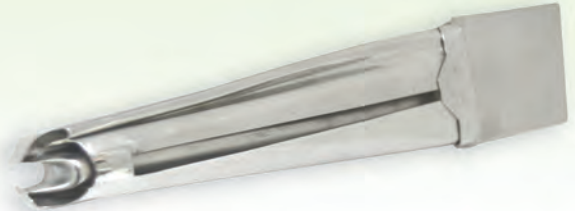
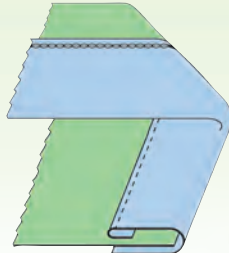

TRİKO APERESİ KNITWEAR ATTACHMENT



- Reçme bant makinaları için üretilmiştir.
- Trikolarnın yaka, ön pat ve kol ağzlarında kullanılır.

- Produced for interlock stitch tape binding machines.
- Collar, placket and cuffs (bottom part of sleeves) of knitwears.

S 712

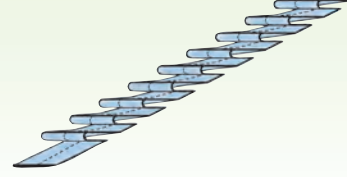
Çıkış
Finish Size
mm

6
8
10
12
15
20
25
30
35
40

EKSTRAFOR PİLE APERESİ DECORATIVE RIBBON (TAPE) PLEAT ATTACHMENT

- Düz dikiş makinaları ve zincir dikiş makinaları için üretilmiştir.
- Tişörtler, yastık, nevresim, perde başta olmak üzere çok amaçlı kullanım yeri vardır.
- Makinaya pile sistemi yapılıdır



- Produced for lockstitch and chainstitch sewing machines.
- Multi-usage, primarily for t-shirts, pillows, bed sheets and curtains.
- A pleat system is installed on the machine.

S 713

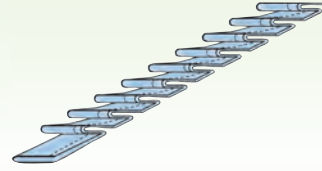
Giriş
Cut
Size
mm

20	10
25	12
30	15
35	17
40	20
45	22
50	25
55	27
60	30
65	32
70	35

İKİYE KATLAMA PİLE APERESİ PLEAT ATTACHMENT FOR FOLDING INTO TWO

- Düz dikiş makinaları ve zincir dikiş makinaları için üretilmiştir.
- Tişörtler, yastık, nevresim, perde başta olmak üzere çok amaçlı kullanım yeri vardır.
- Makinaya pile sistemi yapılıdır



- Produced for lockstitch and chainstitch sewing machines.
- Multi-usage, primarily for t-shirts, pillows, bed sheets and curtains.
- A pleat system is installed on the machine.

S 714

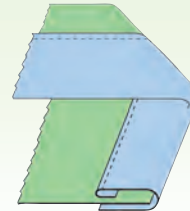
Giriş
Cut
Size
mm

25	8
30	10
32	12
35	13
40	15
45	18
50	20

DÜZ MAKİNE TEK KIVIRMA BİYE APERESİ LOCKSTITCH MACHINE SINGLE FOLDING TAPE BINDING ATTACHMENT

- Düz dikiş makinaları için üretilmiştir.
- Tişörtlerin ense biyeleri başta olmak üzere çok amaçlı kullanım yeri vardır.
- Dişli plaka ve ayak değişir.



- Produced for lockstitch machines.
- Multi-usage, primarily neck part tapes of t-shirts.
- Needle plate, feed dog and foot is changed.

Giriş Cut Size mm	Çıkış Finish Size mm
20	10
25	12
30	15
35	17
40	20

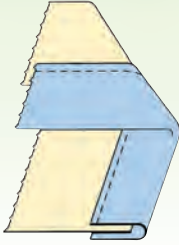

S 715



İKİYE KATLAMA BİYE APERESİ TAPE FOLDING ATTACHMENT



- Düz dikiş makinaları, düz çift iğne ve transportlu düz dikiş makinaları için üretilmiştir.
- Pantolon, mont, deri, penye ve abiye başta olmak üzere çok amaçlı kullanım yerleri vardır.
- Produced for standard, double needle and transport mechanism equipped lockstitch machines.
- Multi-purpose usage such as trousers, jackets, leather products and women dresses.

Giriş Cut Size mm	Çıkış Finish Size mm
25	6
28	7
30	8
35	10
40	12
45	14
50	15

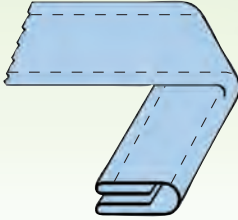

S 716A



S 716B

S 716

ÇİFT İĞNE DÖRTE KATLAMA BİYE APERESİ ATTACHMENTS FOR DOUBLE NEEDLE MACHINES TO FOLD IN FOUR



- Düz çift iğne dikiş makinaları için üretilmiştir.
- Pantolon ve montların kuşak, çantalarn askı kısımlarında kullanılır.
- Produced for double needle lockstitch machines.
- Used for belts of trousers and jackets, hanger parts of bags.

Giriş Cut Size mm	Çıkış Finish Size mm
15	6
18	8
22	10
24	12



S 717

ZİGZAG MAKİNASI AYAĞA ŞERİT APERESİ ZIGZAG MACHINES RIBBON ATTACHMENT



- Zigzag makinaları için üretilmiştir.
- Penye, tişört, mayo ve abiyelerin omuz, göğüs kısımlarında kullanılır.
- Produced for zig-zag machines.
- Used for shoulder and chest parts of combed cotton products, t-shirts, swimming suits and women dresses.

S 718

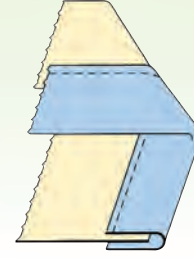

Giriş Cut Size mm	Çıkış Finish Size mm
22	10
22	11
25	12
28	14
30	15
32	16

HALI BİYE APERESİ SAĞ-SOL CARPET TAPE BINDING ATTACHMENT - RIGHT AND LEFT

- Halı kenarı overlok makineleri için üretilmiştir.
- Halı kenarı, oto döşemesi ve başta olmak üzere çok amaçlı kullanım yeri vardır.
- Produced for carpet edge overlock machines.
- Multi-usage, primarily for carpet edges and automobile upholstery.

S 719

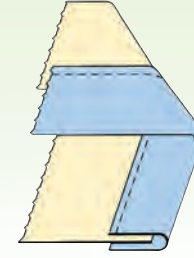

Giriş Cut Size mm	Çıkış Finish Size mm
25	12
28	14
30	15
32	16

HALI SAÇAK APERESİ CARPET FRINGE ATTACHMENT

- Halı şerit makineleri için üretilmiştir.
- Halı saçak dikiminde kullanılır.
- Produced for carpet ribbon machines.
- Used for sewing carpet fringes.

S 720



DÜĞÜMLÜ HALI KENARI APERESİ KNOTTED CARPET EDGE ATTACHMENT

- Halı şerit makineleri için üretilmiştir.
- Halı kenarı dikiminde kullanılır.
- Produced for carpet ribbon machines.
- Used for sewing edges of carpets.



B 801
BİYE ÇARDAĞI
TAPE ROCK



B 801A
ALT TAN BİYE ÇARDAĞI
UPSIDE DOWN TAPE ROCK



B 802
BANT TABLASI
TAPE ROCK



B 802A
MENGENELİ BANT TABLASI
TAPE ROCK WITH VICE



B 802B
MENGENE
VICE

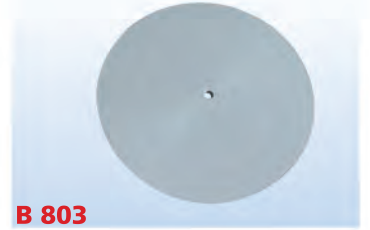

B 803
BİYE PLASTİĞİ
TAPE ELASTIC



B 804
ŞERİT BAĞLANTISI
BELT CONNECTION

B 804B



B 805
ŞERİT BAĞLANTISI
BELT CONNECTION



B 806
REÇME BAĞLANTISI
INTERLOCK CONNECTION



B 807
LASTİK BAĞLANTISI
RUBBER CONNECTION



B 808
ÇİFT İĞNE BAĞLANTISI
DOUBLE NEEDLE CONNECTION



B 809
REÇME DİREĞİ
INTERLOCK CONNECTION

BAĞLANTILAR



B 810

BROTHER OVERLOK BAĞ.
BROTHER OVERLOCK CONNECTION



B 811

SİRUBA, ALDORA, SOMY,
GEMSY OVERLOK BAĞ.
SİRUBA, ALDORA, SOMY, GEMSY OV. CON.



B 812

PEGASUS OVERLOK BAĞ.
PEGASUS OVERLOCK CONNECTION



B 813

JUKİ KİNTEKS, RİMOLDİ OV. BAĞ.
JUKI, KİNTEKS, RİMOLDİ. OV. CON.



B 814

DÜZ MAKİNA BAĞLANTISI
LOCKSTITCH MACHINE CONNECTION

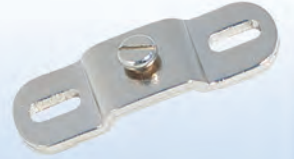

B 815

REÇME BAĞLANTISI
INTERLOCK CONNECTION



B 816

DÜZ MAKİNA BAĞLANTISI
LOCKSTITCH MACHINE CONNECTION



B 817

REÇME-DÜZ MAK. BAĞ.
INTERLOCK-LOCKSTITCH MAC. CONN.



B 818

KOLLU KIZAĞI
LUPPER GUIDE PLATE



B 819

BROTHER OVERLOK BAĞ.
BROTHER OVERLOCK CONNECTION



B 820

SİRUBA, SOMY, GEMSY
OVERLOK BAĞ.
SİRUBA, SOMY, GEMSY OV. CON.



B 821

JUKİ OVERLOK BAĞ.
JUKİ OV. CON.